

XG

- Characteristics
- wide range of forces and ratings
 - long mechanical and electrical life
 - solder, faston and PCB terminals
 - compliant to IEC 60335

Rating 250 VAC, 26 A max.

Dimensions (mm) 27.8 × 15.9 × 10.3

- Actuator
- plunger
 - plain levers
 - roller levers
 - simulated roller levers

Approvals ENEC, UL, cUL, CSA



Preferred Range

Ordering Reference	Actuating Force (N) (ozf)		Operating pos. (mm) (in)		Terminal	Circuit	Actuator	Contacts	Electrical rating ENEC UL/CSA	
XGG2-88Z1	3.20	11.43	14.7	0.57	Faston	CO	Plunger	Ag / AgNi10	16(6) A	15 A
XGG2-88-J23Z1	1.40	5.03	14.9	0.59	Faston	CO	Plain lever	Ag / AgNi10	16(6) A	15 A
XGG2-88-J26Z1	0.91	3.27	14.5	0.57	Faston	CO	Plain lever	Ag / AgNi10	16(6) A	15 A
XGG2-88-J27Z1	0.65	2.34	13.7	0.54	Faston	CO	Plain lever	Ag / AgNi10	16(6) A	15 A
XGG2-88-S20Z1	3.20	11.43	20.2	0.79	Faston	CO	Roller lever	Ag / AgNi10	16(6) A	15 A
XGG2-88-S21Z1	1.55	5.57	20.1	0.79	Faston	CO	Roller lever	Ag / AgNi10	16(6) A	15 A
XGG3-88Z1	3.20	11.43	14.7	0.57	Solder	CO	Plunger	Ag / AgNi10	16(6) A	15 A
XGG6-88Z1	3.20	11.43	14.7	0.57	Faston	CO	Plunger	Ag / AgNi10	16(6) A	15 A
XGC2-88Z1	0.80	2.86	14.7	0.57	Faston	CO	Plunger	Ag / AgNi10	12(6) A	10 A
XGC2-88-J23Z1	0.35	1.26	15.0	0.59	Faston	CO	Plain lever	Ag / AgNi10	12(6) A	10 A
XGC2-88-S20Z1	0.80	2.86	20.2	0.79	Faston	CO	Roller lever	Ag / AgNi10	12(6) A	10 A
XGC6-88Z1	0.80	2.86	14.7	0.57	Faston	CO	Plunger	Ag / AgNi10	12(6) A	10 A
XGK2-88Z1	1.50	5.36	14.7	0.57	Faston	CO	Plunger	Ag / AgNi10	12(6) A	12 A
XGK2-88-J26Z1	0.43	1.55	14.7	0.57	Faston	CO	Plain lever	Ag / AgNi10	12(6) A	12 A
XGK2-88-S21Z1	0.71	2.55	20.2	0.80	Faston	CO	Roller lever	Ag / AgNi10	12(6) A	12 A
XGK3-88Z1	1.50	5.36	14.7	0.57	Solder	CO	Plunger	Ag / AgNi10	12(6) A	12 A
XGK6-88Z1	1.50	5.36	14.7	0.57	Faston	CO	Plunger	Ag / AgNi10	12(6) A	12 A
XG02-88Z1	1.20	4.29	14.5	0.57	Faston	CO	Plunger	Ag / AgNi10	16(6) A	15 A
XG02-88-J27Z1	0.25	0.90	13.6	0.54	Faston	CO	Plain lever	Ag / AgNi10	16(6) A	15 A
XG02-88-S20Z1	1.20	4.29	20.1	0.79	Faston	CO	Roller lever	Ag / AgNi10	16(6) A	15 A
XG06-88Z1	1.20	4.29	14.5	0.57	Faston	CO	Plunger	Ag / AgNi10	16(6) A	15 A

Specifications

Housing	Melamine-Formaldehyd. Thermosetting
Plunger	POM, PPS, MF depending on temperature /type
Mechanism	Snap-action, single pole beryllium bronze blade mechanisme with wiping contacts
Functions	Change-over, normally-closed (except XGG and XGK) or normally-open
Contacts	Fine silver (Ag), silver nickel (AgNi10), gold-plated (Au), silver cadmium oxide (AgCdO)
Terminals	Solder, faston, screw, PCB and side mounting PCB terminals. RAST 5 terminals (5.0 mm pitch)
Temperature range °C	-40° C to +150° C
Mechanical life	2.5 · 10 ⁵ cycles minimum, 50 · 10 ⁶ cycles maximum (Actuation: sinusoidal and maximum up to 80% of the overtravel)
Protection	Enclosure IP40
Mounting	Side mounting via mounting holes
Actuators	Stainless steel

Circuit diagram

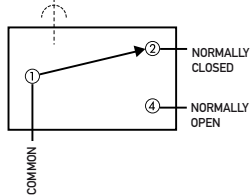

Actuating force/travel

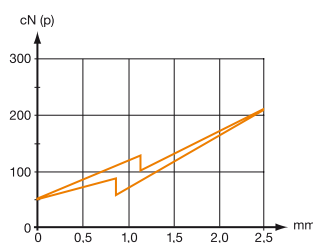

Contact force/travel

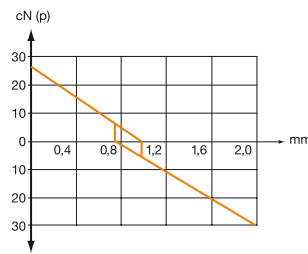

Dimensions

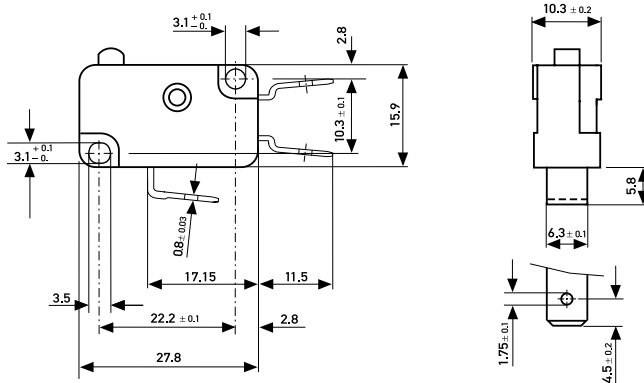

Maximum DC rating

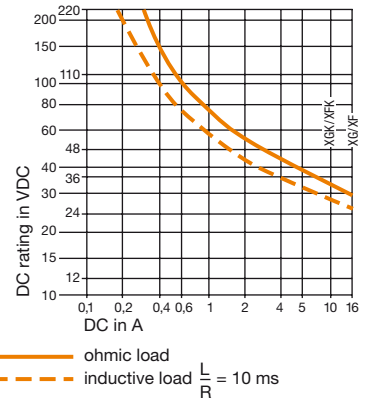

Recommended maximum electrical ratings

	Voltage (VAC)	Approvals ENEC	UL	(VAC)		Voltage (VAC)	Approvals ENEC	UL	(VAC)
XGG...-88	250	16 (6) 5E4	15 A	125/250	XGT...-86	250	26 (10) 25E3	25A	125/250
XGA...-88	250	16 (6) 5E4	15 A	125/250	XGD...-86	250	22 (6) 5E4	21A	125/250
XGM...-88	250	16 (6) 5E4	15 A	125/250	XGA...-86	250	20 (8) 5E4	15A	125/250
XGO...-88	250	16 (6) 5E4	15 A	125/250	XGM...-86	250	20 (8) 5E4	15A	125/250
XGB...-88	250	12 (6) 5E4	12 A	125/250	XGO...-86	250	20 (8) 5E4	15A	125/250
XGC...-88	250	12 (6) 5E4	10 A	125/250	XGA...-86	400	10 (6) 5E4	-	-
XGH...-88	250	12 (6) 5E4	10 A	125/250	XGG...-86	400	10 (6) 5E4	-	-
XGK...-88	250	12 (6) 5E4	12 A	125/250	XGM...-86	400	10 (6) 5E4	-	-
XG....-88	400	3 (2) 5E4	-	-	XGO...-86	400	10 (6) 5E4	-	-

Operating Characteristics

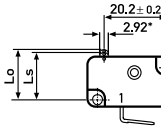
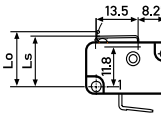
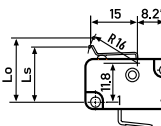
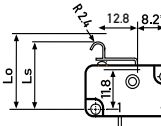
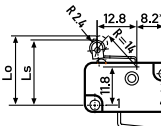
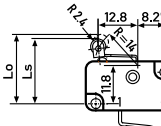
Actuator	Reference	Actuating Force		Release Force		Free Position		Operating Position		Movement Differential		Total travelled position		
		Maximum (N)	(ozf)	Minimum (N)	(ozf)	Maximum (mm)	(in)	(mm)	(in)	Maximum (mm)	(in)	(mm)	(in)	
	XGG..	3.2	11.43	0.4	1.43	15.75	0.62	14.7	$\left. \begin{matrix} 0.57 \\ 0.57 \\ 0.57 \\ 0.57 \\ 0.57 \\ 0.57 \\ 0.57 \\ 0.57 \\ 0.57 \\ 0.57 \end{matrix} \right\} +0.2$ $\left. \begin{matrix} 0.57 \\ 0.57 \\ 0.57 \\ 0.57 \\ 0.57 \\ 0.57 \\ 0.57 \\ 0.57 \\ 0.57 \\ 0.57 \end{matrix} \right\} -0.4$ $\left. \begin{matrix} 0.57 \\ 0.57 \\ 0.57 \\ 0.57 \\ 0.57 \\ 0.57 \\ 0.57 \\ 0.57 \\ 0.57 \\ 0.57 \end{matrix} \right\} +0.007$ $\left. \begin{matrix} 0.57 \\ 0.57 \\ 0.57 \\ 0.57 \\ 0.57 \\ 0.57 \\ 0.57 \\ 0.57 \\ 0.57 \\ 0.57 \end{matrix} \right\} -0.015$	0.35	0.013	13.2	0.519	
	XGA..	3.2	11.43	0.6	2.14	15.75	0.62	14.7		0.15	0.006	13.2	0.519	
	XGM..	2	7.14	0.5	1.79	15.6	0.61	14.5		0.35	0.013	13.7	0.539	
	XGO..	1.2	4.29	0.1	0.36	15.6	0.61	14.5		0.35	0.013	13.7	0.539	
	XGK..	1.5	5.36	0.2	0.71	15.75	0.62	14.7		0.35	0.013	13.2	0.519	
	XGB..	1.5	5.36	0.3	1.07	15.75	0.62	14.7		0.15	0.006	13.2	0.519	
	XGC..	0.8	2.86	0.1	0.36	15.75	0.62	14.7		0.15	0.006	13.2	0.519	
	XGH..	0.45	1.61	0.05	0.18	15.6	0.61	14.5		0.35	0.013	13.7	0.539	
	XGT..	3.2	11.43	0.6	2.14	15.75	0.62	14.7		0.15	0.006	13.2	0.519	
	XGD..	1.7	6.07	0.15	0.54	15.75	0.62	14.7		0.15	0.006	13.2	0.519	
	XGG..	3.2	11.43	0.36	1.29	16.5	0.64	15.1 ± 0.5	0.59 ± 0.019	0.4	0.015	14	0.551	
	XGA..	3.2	11.43	0.54	1.93	16.5	0.64	15.1 ± 0.5	0.59 ± 0.019	0.2	0.007	14	0.551	
	XGM..	2	7.14	0.45	1.61	16.5	0.64	15 ± 0.5	0.59 ± 0.019	0.4	0.015	14.4	0.566	
	XGO..	1.2	4.29	0.09	0.34	16.5	0.64	15 ± 0.5	0.59 ± 0.019	0.4	0.015	14.4	0.566	
	XGK..	1.5	5.36	0.18	0.64	16.5	0.64	15.1 ± 0.5	0.59 ± 0.019	0.4	0.015	14	0.551	
	XGB..	1.5	5.36	0.27	0.96	16.5	0.64	15.1 ± 0.5	0.59 ± 0.019	0.2	0.007	14	0.551	
	XGC..	0.8	2.86	0.09	0.32	16.5	0.64	15.1 ± 0.5	0.59 ± 0.019	0.2	0.007	14	0.551	
	XGH..	0.45	1.61	0.04	0.14	16.5	0.64	15 ± 0.5	0.59 ± 0.019	0.4	0.015	14.4	0.566	
	Width of lever 7 mm/0.28 in – also available with width 4 mm/0.16 in													
		XGG..	2.6	9.29	0.32	1.14	19.2	0.75	17.5 ± 0.7	0.68 ± 0.027	0.45	0.017	16.4	0.645
XGA..		2.6	9.29	0.48	1.71	19.2	0.75	17.5 ± 0.7	0.68 ± 0.027	0.2	0.007	16.4	0.645	
XGM..		1.65	5.89	0.4	1.43	19.2	0.75	17.3 ± 0.7	0.68 ± 0.027	0.45	0.017	16.9	0.665	
XGO..		1	3.57	0.08	0.29	19.2	0.75	17.3 ± 0.7	0.68 ± 0.027	0.45	0.017	16.9	0.665	
XGK..		1.25	4.46	0.16	0.57	19.2	0.75	17.5 ± 0.7	0.68 ± 0.027	0.45	0.017	16.4	0.645	
XGB..		1.25	4.46	0.24	0.86	19.2	0.75	17.5 ± 0.7	0.68 ± 0.027	0.2	0.007	16.4	0.645	
XGC..		0.65	2.32	0.08	1.29	19.2	0.75	17.5 ± 0.7	0.68 ± 0.027	0.2	0.007	16.4	0.645	
XGH..		1.37	1.32	0.04	0.14	19.2	0.75	17.3 ± 0.7	0.68 ± 0.027	0.45	0.017	16.9	0.665	
Width of lever 7 mm/0.28 in														
		XGG..	3.2	11.43	0.38	1.36	21.8	0.85	20.5 ± 0.6	0.81 ± 0.023	0.4	0.015	19.5	0.767
	XGA..	3.2	11.43	0.85	3.04	21.8	0.85	20.5 ± 0.6	0.81 ± 0.023	0.2	0.007	19.5	0.767	
	XGM..	2	7.14	0.48	1.71	21.8	0.85	20.3 ± 0.6	0.8 ± 0.023	0.4	0.015	19.8	0.779	
	XGO..	1.2	4.29	0.09	0.32	21.8	0.85	20.1 ± 0.6	0.79 ± 0.023	0.4	0.015	19.8	0.779	
	XGK..	1.5	5.36	0.19	0.68	21.8	0.85	20.5 ± 0.6	0.81 ± 0.023	0.4	0.015	19.5	0.767	
	XGB..	1.5	5.36	0.29	1.04	21.8	0.85	20.5 ± 0.6	0.81 ± 0.023	0.2	0.007	19.5	0.767	
	XGC..	0.8	2.86	0.09	0.32	21.8	0.85	20.5 ± 0.6	0.81 ± 0.023	0.2	0.007	19.5	0.767	
	XGH..	0.45	1.61	0.04	0.14	21.8	0.85	20.3 ± 0.6	0.8 ± 0.023	0.4	0.015	19.8	0.779	
	Width of lever 7 mm/0.28 in													
		XGG..	3.2	11.43	0.37	1.32	21.8	0.85	20.2 ± 0.7	0.79 ± 0.027	0.4	0.015	19.3	0.759
XGA..		3.2	11.43	0.56	2	21.8	0.85	20.2 ± 0.7	0.79 ± 0.027	0.2	0.007	19.3	0.759	
XGM..		2	7.14	0.47	1.68	21.8	0.85	20.1 ± 0.7	0.79 ± 0.027	0.4	0.015	19.7	0.775	
XGO..		1.2	4.29	0.09	0.32	21.8	0.85	20.1 ± 0.7	0.79 ± 0.027	0.4	0.015	19.7	0.775	
XGK..		1.5	5.36	0.18	0.64	21.8	0.85	20.2 ± 0.7	0.79 ± 0.027	0.4	0.015	19.3	0.759	
XGB..		1.5	5.36	0.28	1	21.8	0.85	20.2 ± 0.7	0.79 ± 0.027	0.2	0.007	19.3	0.759	
XGC..		0.8	2.86	0.09	0.32	21.8	0.85	20.2 ± 0.7	0.79 ± 0.027	0.2	0.007	19.3	0.759	
XGH..		0.45	1.61	0.04	0.14	21.8	0.85	20.1 ± 0.7	0.79 ± 0.027	0.4	0.015	19.7	0.775	
Width of roller 6.6 mm/0.26 in														
		XGG..	3.2	11.43	0.37	1.32	21.8	0.85	20.2 ± 0.7	0.79 ± 0.027	0.4	0.015	19.3	0.759
	XGA..	3.2	11.43	0.56	2	21.8	0.85	20.2 ± 0.7	0.79 ± 0.027	0.2	0.007	19.3	0.759	
	XGM..	2	7.14	0.05	1.68	21.8	0.85	20.1 ± 0.7	0.79 ± 0.027	0.4	0.015	19.7	0.775	
	XGO..	1.2	4.29	0.09	0.32	21.8	0.85	20.1 ± 0.7	0.79 ± 0.027	0.4	0.015	19.7	0.775	
	XGK..	1.5	5.36	0.18	0.64	21.8	0.85	20.2 ± 0.7	0.79 ± 0.027	0.4	0.015	19.3	0.759	
	XGB..	1.5	5.36	0.28	1	21.8	0.85	20.2 ± 0.7	0.79 ± 0.027	0.2	0.007	19.3	0.759	
	XGC..	0.8	2.86	0.09	0.32	21.8	0.85	20.2 ± 0.7	0.79 ± 0.027	0.2	0.007	19.3	0.759	
	XGH..	0.45	1.61	0.04	0.14	21.8	0.85	20.1 ± 0.7	0.79 ± 0.027	0.4	0.015	19.7	0.775	
	Width of roller 6.6 mm/0.26 in													

¹⁾ Lever distance 8.2 (0.32) for lever position –20, lever position (–J20, L20, S20, M20)
Lever distance 14.0 (0.55) for lever position –40, lever position (–J40, L40, S40, M40)

* For high temperature T125°C/T 150°C (ENEC, UL)

Ordering Reference

Basic type	XGG..	3.2 N	11,43 ozf	Example: XG	4	2	A	-88	J20	Z1
	XGA..	3.2 N	11,43 ozf							
	XGM..	2.0 N	7,14 ozf							
	XGO..	1.2 N	4,29 ozf							
	XGK..	1.5 N	5,36 ozf							
	XGB..	1.5 N	5,36 ozf							
	XGC..	0.8 N	2,86 ozf							
	XGH..	0,45 N	1,61 ozf							
	XGD..	1.7 N	6,07 ozf							
	XGT..	3.2 N	11,43 ozf							

Circuit	No symbol, change-over
4	Normally closed (NC)
5	Normally open (NO)

Terminals	2	Faston	6,3 × 0,8
	3	Solder	1,7 × 3,2
	4	Faston	1 × 2,8 × 0,5 DIN
	5	Faston	1 × 2,8 × 0,5
	6	Faston	4,8 × 0,5
	7	Screw	
	8	Faston	1 × 2,8 × 0,8 DIN
	9	Faston	1 × 2,8 × 0,8
	10	Faston	4,8 × 0,8
	11	Faston	2 × 2,8 × 0,8
	12	Short solder	∅ 2,3
	13	Print bent (lid)	
	14	Print bent (base)	
	15	Rast 5	6,3 × 0,8
	19	Short solder	∅ 1,7

Other types of terminals are available on request

Version	Number of operations at rated load			
	ENEC	UL	Europe	UL
	No symbol, T85	T90	50.000	6.000
A	T85	T90	50.000	100.000
W	T150	T150	50.000	6.000
AW	T150	T150	50.000	100.000
B	T85	T90	10.000	6.000
V	T125	T130	50.000	6.000
AV	T125	T130	50.000	100.000
C	T85	T90	25.000	6.000

Contacts	-88	Ag / AgNi10
	-81	Gold-plated 4 µm (Au) on Ag
	-86	Ag / Ag CdO

Actuators	No symbol, plunger		
	J20 ¹⁾	J40 ²⁾	Plain lever 13,5 mm
	J22 ¹⁾	J42 ²⁾	Plain lever 24,0 mm
	J23 ¹⁾	J43 ²⁾	Plain lever 27,8 mm
	J27 ¹⁾	J47 ²⁾	Plain lever 60,0 mm
	M20 ¹⁾	M40 ²⁾	Plain lever formed 14,7 mm
	L20 ¹⁾	L40 ²⁾	Cam follower 12,8 mm
	L21 ¹⁾	L41 ²⁾	Cam follower 26,2 mm
	S20 ¹⁾	S40 ²⁾	Roller lever 12,8 mm
	T20 ¹⁾	T40 ²⁾	Roller lever, 150° C version 12,8 mm

Other actuators available on request

- ¹⁾ Lever distance 8.2 (0.32) for lever position –.20, lever position (–J20, L20, S20, M20)
²⁾ Lever distance 14.0 (0.55) for lever position –.40, lever position (–J40, L40, S40, M40)

Approvals	No symbol, ENEC
	Z1 UL, CSA