

# Advanced Digital Temperature Controller E5AN-H/E5EN-H (96 x 96 mm and 48 x 96 mm)

**A New High-performance Controller:  
High Resolution, High Speed, and High Input Accuracy.  
With Logic Operations and preventive maintenance functions.  
Plus Infrared Port on Front Panel.**

- High-resolution display with 5 digits/0.01°C display.
- High-speed sampling cycle of 60 ms.
- High Accuracy  
Thermocouple/Pt input: ±0.1% of PV  
Analog input: ±0.1% FS
- Universal inputs on all models (thermocouple, PT, analog) to handle various sensors with one Controller. Models also available with Remote SP.
- A PV/SV-status display function can be set to displaying the PV or SV and the status of the Temperature Controller (auto/manual, RUN/STOP and alarms).
- Flexible contact outputs with logic operations (AND, OR, and delays) set from the Support Software (CX-Thermo Ver. 4.0)
- Preventive maintenance for relays using a Control Output ON/OFF Counter.
- Model available with position-proportional control



96 x 96 mm  
E5AN-H

48 x 96 mm  
E5EN-H

**NEW**

Refer to *Safety Precautions* on page 22.

## Main I/O Functions

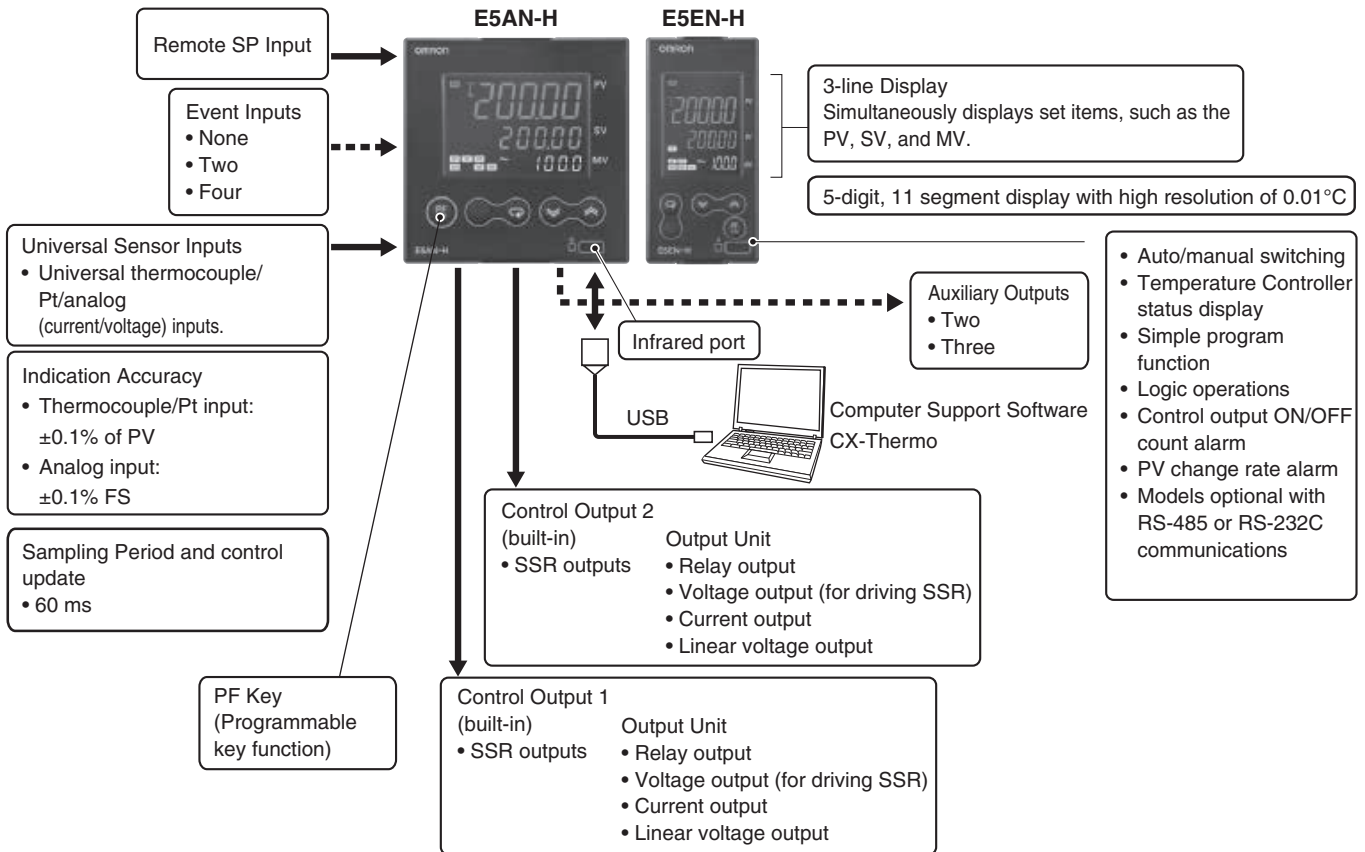

# Lineup

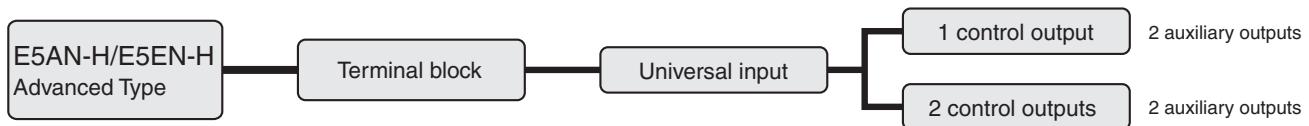

**Note:** All controllers can be used for Heating, Cooling and Heating & Cooling control.

## Model Number Structure

### Model Number Legend

#### Controllers

**E5AN/E5EN-H**           **M**  **-500**

1 2 3 4 5 6 7 8 9 10

1. **Type**  
H: Advanced
2. **3. 4. Control mode, output 1 and output 2**  
AA: 2 slots for control output module  
SS: 2 SSR outputs fitted  
PRR: position (valve) control, 2 Relays fitted
5. **Auxiliary Outputs**  
2: Two outputs  
3: Three outputs
6. **Option 1**  
Blank: None  
H: Heater burnout/SSR failure/Heater overcurrent detection (For 1-phase heater applications, 1x CT)  
HH: Heater burnout/SSR failure/Heater overcurrent detection (For 3-phase heater applications, 2x CT)
7. **Option 2**  
B: Two event inputs  
BF: Event input + Transfer output
8. **Option 3**  
M: Option Unit can be mounted.
9. **Power Supply Voltage**  
Blank: 100 to 240 VAC  
D: 24 VAC/VDC
10. **Terminal Cover**  
-500: With Terminal Cover

#### Option Units

**E53-**   
1

1. **Function**  
EN01: RS-232C communications  
EN02: RS-422 communications  
EN03: RS-485 communications  
AKB: Event input

#### Output Units

**E53-**   
1

1. **Function**  
RN: relay  
QN: pulse (PNP) 12 VDC  
Q3: pulse (NPN) 12 VDC  
Q4: pulse (PNP) 24 VDC  
C3N: linear 4 to 20 mA  
C3DN: linear 0 to 20 mA  
V34N: linear 0 to 10 V  
V35N: linear 0 to 5 V

**Note:** Casing color is black. White/Silver available on request.

This data sheet is provided as a guideline for selecting products. Be sure to refer to the following user manuals for application precautions and other information required for operation before attempting to use the product.

E5CN-H/E5AN-H/E5EN-H Digital Controllers User's Manual Advanced Type (Cat. No. H157)

E5CN-H/E5AN-H/E5EN-H Digital Controllers Communications Manual Advanced Type (Cat. No. H159)

# Ordering Information

## E5AN-H

Size	Case color	Power supply voltage	Control method	Auxiliary output	Control output 1/2	Heater burnout	Optional functions			Model
							Event inputs	Transfer output	Remote setpoint	
1/4 DIN 96 × 96 × 78 (W × H × D)	Black	100 to 240 VAC	Basic	2	none fitted, 2 slots	1-phase	2		4 to 20-mA input	E5AN-HAA2HBM-500
					2 SSR output fitted	1-phase	2		4 to 20-mA input	E5AN-HSS2HBM-500
				none fitted, 2 slots	3-phase	2	4 to 20-mA output	4 to 20-mA input	E5AN-HAA2HHBFM-500	
				2 SSR output fitted	3-phase	2	4 to 20-mA output	4 to 20-mA input	E5AN-HSS2HHBFM-500	
			3	none fitted, 2 slots		2	4 to 20-mA output	4 to 20-mA input	E5AN-HAA3BFM-500	
				2 SSR output fitted		2	4 to 20-mA output	4 to 20-mA input	E5AN-HSS3BFM-500	
		Valve	2	2 relay output fitted		2		4 to 20-mA input	E5AN-HPRR2BM-500	
				2 relay output fitted		2	4 to 20-mA output	4 to 20-mA input	E5AN-HPRR2BFM-500	
		24 VAC/VDC	Basic	2	none fitted, 2 slots	1-phase	2		4 to 20-mA input	E5AN-HAA2HBMD-500
					2 SSR output fitted	1-phase	2		4 to 20-mA input	E5AN-HSS2HBMD-500
				none fitted, 2 slots	3-phase	2	4 to 20-mA output	4 to 20-mA input	E5AN-HAA2HHBFMD-500	
				2 SSR output fitted	3-phase	2	4 to 20-mA output	4 to 20-mA input	E5AN-HSS2HHBFMD-500	
			3	none fitted, 2 slots		2	4 to 20-mA output	4 to 20-mA input	E5AN-HAA3BFMD-500	
				2 SSR output fitted		2	4 to 20-mA output	4 to 20-mA input	E5AN-HSS3BFMD-500	
		Valve	2	2 relay output fitted		2		4 to 20-mA input	E5AN-HPRR2BMD-500	
				2 relay output fitted		2	4 to 20-mA output	4 to 20-mA input	E5AN-HPRR2BFMD-500	

**Note:** Add power supply voltage to model to complete ordering code (ie. E5AN-HAA2HBM-500 AC100-240 or E5AN-HAA2HBMD-500 AC/DC24)

**Note:** Heater alarm = heater burnout + SSR short detection + SSR overcurrent

**Note:** For output option modules (AA), see “output modules E53- N” on page 2

## E5EN-H

Size	Case color	Power supply voltage	Control method	Auxiliary output	Control output 1/2	Heater burnout	Optional Functions			Model	
							Event inputs	Transfer output	Remote setpoint		
1/8 DIN 48 × 96 × 78 (W × H × D)	Black	100 to 240 VAC	Basic	2	none fitted, 2 slots	1-phase	2		4 to 20-mA input	E5EN-HAA2HBM-500	
					2 SSR output fitted	1-phase	2		4 to 20-mA input	E5EN-HSS2HBM-500	
					none fitted, 2 slots	3-phase	2	4 to 20-mA output	4 to 20-mA input	E5EN-HAA2HHBFM-500	
					2 SSR output fitted	3-phase	2	4 to 20-mA output	4 to 20-mA input	E5EN-HSS2HHBFM-500	
				3	none fitted, 2 slots		2	4 to 20-mA output	4 to 20-mA input	E5EN-HAA3BFM-500	
					2 SSR output fitted		2	4 to 20-mA output	4 to 20-mA input	E5EN-HSS3BFM-500	
		Valve	2	2 relay output fitted		2		4 to 20-mA input	E5EN-HPRR2BM-500		
				2 relay output fitted		2	4 to 20-mA output	4 to 20-mA input	E5EN-HPRR2BFM-500		
		24 VAC/ VDC	Basic	2	2	none fitted, 2 slots	1-phase	2		4 to 20-mA input	E5EN-HAA2HBMD-500
						2 SSR output fitted	1-phase	2		4 to 20-mA input	E5EN-HSS2HBMD-500
						none fitted, 2 slots	3-phase	2	4 to 20-mA output	4 to 20-mA input	E5EN-HAA2HHBFMD-500
						2 SSR output fitted	3-phase	2	4 to 20-mA output	4 to 20-mA input	E5EN-HSS2HHBFMD-500
				3	none fitted, 2 slots		2	4 to 20-mA output	4 to 20-mA input	E5EN-HAA3BFMD-500	
					2 SSR output fitted		2	4 to 20-mA output	4 to 20-mA input	E5EN-HSS3BFMD-500	
Valve	2			2 relay output fitted		2		4 to 20-mA input	E5EN-HPRR2BMD-500		
				2 relay output fitted		2	4 to 20-mA output	4 to 20-mA input	E5EN-HPRR2BFMD-500		

**Note:** Add power supply voltage to model to complete ordering code (ie. E5EN-HAA2HBM-500 AC100-240 or E5EN-HAA2HBMD-500 AC/DC24)

**Note:** Heater alarm = heater burnout + SSR short detection + SSR overcurrent

**Note:** For output option modules (AA), see "output modules E53- N" on page 2

## Accessories (Order Separately)

### USB-infrared Conversion Cable

Model
E58-CIFIR

### USB-Serial Conversion Cable

Model
E58-CIFQ1

### Terminal Cover

Connectable models	Model
E5AN-H	E53-COV16
E5EN-H	

**Note:** The Terminal Cover comes with the E5CN-□□□-500 models.

### Waterproof Packing

Connectable models	Model
E5AN-H	Y92S-P4
E5EN-H	Y92S-P5

**Note:** The Waterproof Packing is included with the Controller.

### Current Transformers (CTs)

Hole diameter	Model
5.8 dia.	E54-CT1
12.0 dia.	E54-CT3

### CX-Thermo Support Software

Model
EST2-2C-MV4

# Specifications

## Ratings

<b>Power supply voltage</b>	No D in model number: 100 to 240 VAC, 50/60 Hz D in model number: 24 VAC, 50/60 Hz; 24 VDC	
<b>Operating voltage range</b>	85% to 110% of rated supply voltage	
<b>Power consumption</b>	100 to 240 VAC: 12 VA 24 VAC/VDC: 8.5 VA (24 VAC)/5.5 W (24 VDC)	
<b>Sensor input</b>	Any of the following can be selected. Thermocouple: K, J, T, E, L, U, N, R, S, B, W, or PL II Platinum resistance thermometer: Pt100 or JPt100 Current input: 4 to 20 mA or 0 to 20 mA Voltage input: 1 to 5 V, 0 to 5 V, or 0 to 10 V	
<b>Input impedance</b>	Current input: 150 Ω max., Voltage input: 1 MΩ min. (Use a 1:1 connection when connecting the ES2-HB.)	
<b>Control method</b>	ON/OFF control or 2-PID control (with auto-tuning)	
<b>Control output</b>	<b>Relay output</b>	Output Unit (Install the Output Unit (sold separately).)
	<b>Voltage output (for driving SSR)</b>	
	<b>Current output</b>	
	<b>Linear voltage output</b>	
	<b>Built-in SSR output</b>	
<b>Relay output for position-proportional control</b>	Relay output: Open and close: SPST-NO, 250 VAC, 1 A (including in-rush current), electrical life: 100,000 operations min. Potentiometer input: Must be between 100 Ω and 2.5 kΩ for maximum open position.	
<b>Auxiliary output</b>	<b>Number of outputs</b>	2 or 3 max.
	<b>Output specifications</b>	Relay output: SPST-NO, 250 VAC, 3 A (resistive load), electrical life: 100,000 operations, minimum applicable load: 5 V, 10 mA
<b>Event input</b>	<b>Number of outputs</b>	2 (standard) or 4 (with an E53-AKB)
	<b>External contact input specifications</b>	Contact input: ON: 1 kΩ max., OFF: 100 kΩ min.
		Non-contact input: ON: Residual voltage: 1.5 V max., OFF: Leakage current: 0.1 mA max. Current flow: Approx. 7 mA per contact
<b>Logic operations</b>	<b>Number of operations</b>	8 max.
	<b>Operations</b>	<ul style="list-style-type: none"> <li>Logic operation: Any of the following four patterns can be selected. The input status may be inverted. (A and B) or (C and D), (A or C) and (B or D), A or B or C or D, A and B and C and D (A, B, C, and D are four inputs.)</li> <li>Delay: ON delay or OFF delay for the results of the logic operation given above. Setting time: 0 to 9999 s or 0 to 9999 min</li> <li>Output inversion: Possible</li> </ul>
		<b>Output</b>
	<b>Work bit assignment</b>	Any of The following can be assigned to up to eight work bits (logic operation results): Event input operations, auxiliary outputs, or control outputs.
<b>Transfer outputs</b>	<b>Number of outputs</b>	1 max. (Depends on model. Models with transfer output (F in model number)
	<b>Output specifications</b>	Current output: 4 to 20 mA DC, Load: 600 Ω max., Resolution at 4 to 20 mA: Approx. 10,000
<b>RSP input</b>	<b>Number of inputs</b>	1
	<b>Signal type</b>	Current input: 4 to 20 mA (input impedance: 150 Ω ±10%)
	<b>Analog input scaling</b>	Scaling of signal to engineering units (EU) -19,999 to 30,000 (display: 30,000 max.)
	<b>Accuracy</b>	(±0.2% of FS) ±1 digit max.
	<b>Input sampling period</b>	60 ms
<b>Setting method</b>	Set digitally using keys on the front panel or by using the RSP input.	
<b>Indication method</b>	11-segment digital display and individual indicators (7-segments display emulation also possible) Character height: E5AN-H: PV: 15.8 mm, SV: 9.5 mm, MV: 6.8 mm; E5EN-H: PV: 11.8 mm, SV: 8.1 mm, MV: 5.8 mm Content of 3-level display: PV/SV/MV, PV/SV/Bank No., or soak time remain Number of digits: 5 for PV and SV, 4 for MV	
<b>Bank switching</b>	Supported (number of banks: 8) Local SP, alarm settings, PID sets (PID constants, MV upper limit, MV lower limit, etc.)	
<b>Other functions</b>	Manual output, heating/cooling control, loop burnout alarm, SP ramp, other alarm functions, heater burnout detection, 40% AT, 100% AT, MV limiter, input digital filter, self-tuning, temperature input shift, run/stop, protection functions, control output ON/OFF counter, extraction of square root, MV change rate limit, PV/SV status display, logic operations, automatic cooling coefficient adjustment	
<b>Ambient operating temperature</b>	-10 to 55°C (with no condensation or icing), for 3-year warranty: -10 to 50°C	
<b>Ambient operating humidity</b>	25% to 85%	
<b>Storage temperature</b>	-25 to 65°C (with no condensation or icing)	

# Input Ranges

## Thermocouple/Platinum Resistance Thermometer (Fully Universal Inputs)

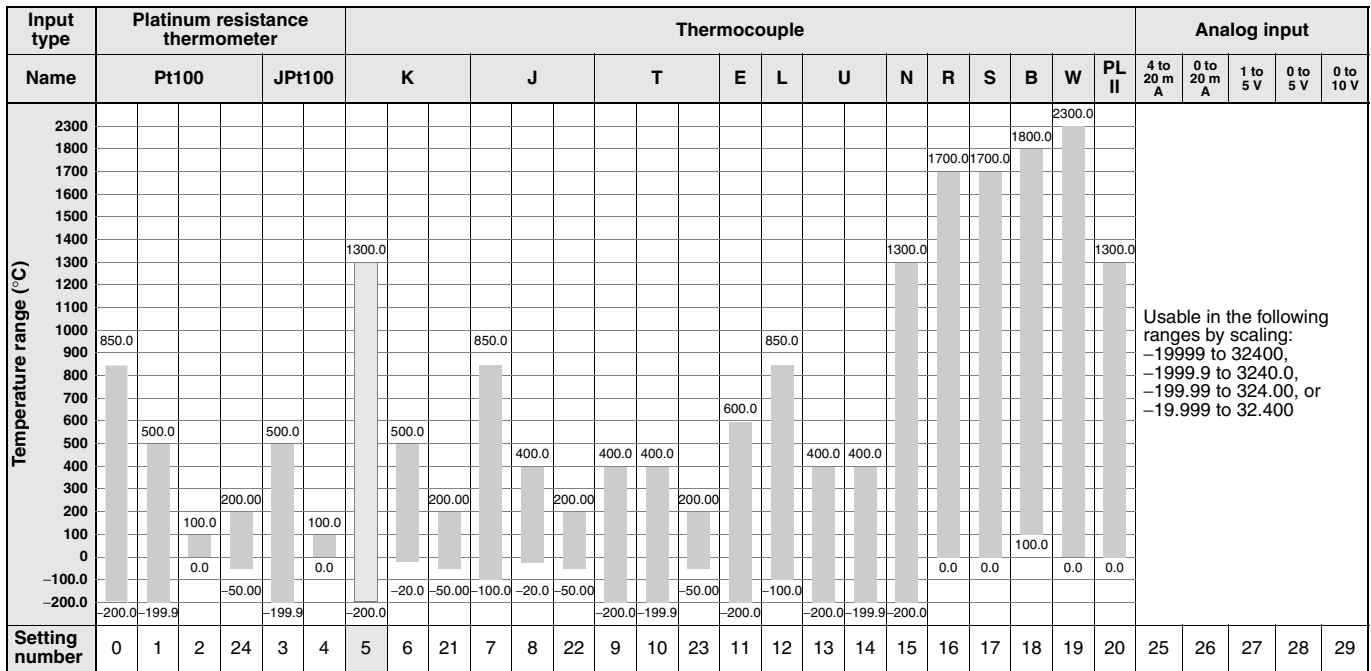

Shaded settings are the default settings.

The applicable standards for the input types are as follows:

K, J, T, E, N, R, S, B: JIS C 1602-1995, IEC 584-1

L: Fe-CuNi, DIN 43710-1985

U: Cu-CuNi, DIN 43710-1985

W: W5Re/W26Re, ASTM E988-1990

JPt100: JIS C 1604-1989, JIS C 1606-1989

Pt100: JIS C 1604-1997, IEC 751

PL II: According to Platinel II electromotive force charts from BASF (previously Engelhard)

# Alarm Outputs

Each alarm can be independently set to one of the following 15 alarm types. The default is 2: *Upper limit*. Auxiliary outputs are allocated for alarms. ON delays and OFF delays (0 to 999 s) can also be specified.

**Note:** For models with heater burnout, SSR failure, and heater overcurrent detection, alarm 1 will be an OR output of the alarm selected from the following alarm types and the alarms for heater burnout, SSR failure, and heater overcurrent. To output only a heater burnout alarm, SSR failure alarm, and heater overcurrent alarm for alarm 1, set the alarm type to 0 (i.e., no alarm function).

Set value	Alarm type	Alarm output operation	
		When X is positive	When X is negative
0	Alarm function OFF	Output OFF	
1 *1	Upper- and lower-limit	ON OFF	*2
2	Upper limit	ON OFF	ON OFF
3	Lower limit	ON OFF	ON OFF
4 *1	Upper- and lower-limit range	ON OFF	*3
5 *1	Upper- and lower-limit with standby sequence	ON OFF	*4
6	Upper-limit with standby sequence	ON OFF	ON OFF
7	Lower-limit with standby sequence	ON OFF	ON OFF
8	Absolute-value upper-limit	ON OFF	ON OFF
9	Absolute-value lower-limit	ON OFF	ON OFF
10	Absolute-value upper-limit with standby sequence	ON OFF	ON OFF
11	Absolute-value lower-limit with standby sequence	ON OFF	ON OFF
12	LBA (for alarm 1 only)	---	
13	PV change rate alarm	---	
14	RSP absolute value upper limit *6	ON OFF	ON OFF
15	RSP absolute value lower limit *6	ON OFF	ON OFF

\*1. With set values 1, 4 and 5, the upper and lower limit values can be set independently for each alarm type, and are expressed as "L" and "H."

\*2. Set value: 1, Upper- and lower-limit alarm

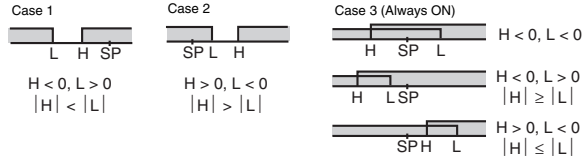

\*3. Set value: 4, Upper- and lower-limit range

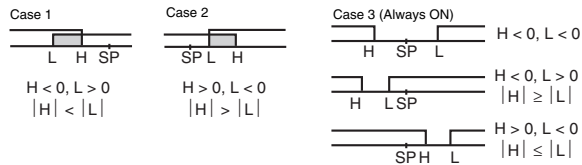

\*4. Set value: 5, Upper- and lower-limit with standby sequence For Upper- and Lower-Limit Alarm Described Above

- Case 1 and 2 **Always OFF** when the upper-limit and lower-limit hysteresis overlaps.
- Case 3: **Always OFF**

\*5. Set value: 5, Upper- and lower-limit with standby sequence **Always OFF** when the upper-limit and lower-limit hysteresis overlaps.

\*6. Displayed when there is a remote SP input.

## Characteristics

<b>Indication accuracy</b>	Thermocouple: ( $\pm 0.1\%$ of indicated value or $\pm 1^\circ\text{C}$ , whichever is greater) $\pm 1$ digit max. *1 Platinum resistance thermometer: ( $\pm 0.1\%$ of indicated value or $\pm 0.5^\circ\text{C}$ , whichever is greater) $\pm 1$ digit max. Analog input: $\pm 0.1\%$ FS $\pm 1$ digit max. CT input: $\pm 5\%$ FS $\pm 1$ digit max. Potentiometer input: $\pm 5\%$ FS $\pm 1$ digit max.	
<b>Transfer output accuracy</b>	$\pm 0.3\%$ FS max.	
<b>Influence of temperature *2</b>	Thermocouple input (R, S, B, W, PL II): ( $\pm 1\%$ of PV or $\pm 10^\circ\text{C}$ , whichever is greater) $\pm 1$ digit max. Other thermocouple input: ( $\pm 1\%$ of PV or $\pm 4^\circ\text{C}$ , whichever is greater) $\pm 1$ digit max. *3	
<b>Influence of voltage *2</b>	Platinum resistance thermometer: ( $\pm 1\%$ of PV or $\pm 2^\circ\text{C}$ , whichever is greater) $\pm 1$ digit max. Analog input: ( $\pm 1\%$ FS) $\pm 1$ digit max.	
<b>Input sampling period</b>	60 ms	
<b>Hysteresis</b>	Temperature input: 0.1 to 3240.0°C or °F (in units of 0.1°C or °F) Analog input: 0.01% to 99.99% FS (in units of 0.01% FS)	
<b>Proportional band (P)</b>	Temperature input: 0.1 to 3240.0°C or °F (in units of 0.1°C or °F) Analog input: 0.1% to 999.9% FS (in units of 0.1% FS)	
<b>Integral time (I)</b>	0.0 to 3240.0 s (in units of 0.1 s)	
<b>Derivative time (D)</b>	0.0 to 3240.0 s (in units of 0.1 s)	
<b>Control period</b>	0.5, 1 to 99 s (in units of 1 s)	
<b>Manual reset value</b>	0.0 to 100.0% (in units of 0.1%)	
<b>Alarm setting range</b>	-19999 to 32400 (decimal point position depends on input type)	
<b>Affect of signal source resistance</b>	Thermocouple: 0.1°C/Ω max. (100 Ω max.) Platinum resistance thermometer: 0.1°C/Ω max. (10 Ω max.)	
<b>Insulation resistance</b>	20 MΩ min. (at 500 VDC)	
<b>Dielectric strength</b>	2,300 VAC, 50 or 60 Hz for 1 min (between terminals with different charge)	
<b>Vibration resistance</b>	<b>Malfunction</b>	10 to 55 Hz, 20 m/s <sup>2</sup> for 10 min each in X, Y, and Z directions
	<b>Destruction</b>	10 to 55 Hz, 0.75-mm single amplitude for 2 hrs each in X, Y, and Z directions
<b>Shock resistance</b>	<b>Malfunction</b>	100 m/s <sup>2</sup> , 3 times each in X, Y, and Z directions
	<b>Destruction</b>	300 m/s <sup>2</sup> , 3 times each in X, Y, and Z directions
<b>Weight</b>	<b>E5AN-H</b>	Controller: Approx. 310 g, Mounting Bracket: Approx. 100 g
	<b>E5EN-H</b>	Controller: Approx. 260 g, Mounting Bracket: Approx. 100 g
<b>Degree of protection</b>	Front panel: IP66, Rear case: IP20, Terminals: IP00	
<b>Memory protection</b>	Non-volatile memory (number of writes: 1,000,000 times)	
<b>Setup Tool</b>	CX-Thermo version 4.0 or higher	
<b>Setup Tool port</b>	Provided on the bottom of the E5AN-H and E5EN-H. An E58-CIFQ1 USB-Serial Conversion Cable is required to connect the computer to the E5AN-H and E5EN-H. Provided on the front of the E5AN-H and E5EN-H. An E58-CIFIR USB-infrared Conversion Cable is required to connect the computer to the E5AN-H or E5EN-H. *4	
<b>Standards</b>	<b>Approved standards</b>	UL 61010-1, CSA C22.2 No. 1010-1
	<b>Conformed standards</b>	EN 61010-1 (IEC 61010-1): Pollution level 2, overcurrent category II
<b>EMC</b>	EMI: Radiated Interference Electromagnetic Field Strength: Noise Terminal Voltage: EMS: ESD Immunity: Electromagnetic Field Immunity: Burst Noise Immunity: Conducted Disturbance Immunity: Surge Immunity: Power Frequency Magnetic Field Immunity: Voltage Dip/Interrupting Immunity:	EN 61326 EN 55011 Group 1, class A EN 55011 Group 1, class A EN 61326 EN 61000-4-2 EN 61000-4-3 EN 61000-4-4 EN 61000-4-6 EN 61000-4-5 EN 61000-4-8 EN 61000-4-11

\*1. The indication accuracy of K thermocouples in the  $-200$  to  $1300^\circ\text{C}$  range, T and N thermocouples at a temperature of  $-100^\circ\text{C}$  max., and U and L thermocouples at any temperatures is  $\pm 2^\circ\text{C} \pm 1$  digit max. The indication accuracy of the B thermocouple at a temperature of  $400^\circ\text{C}$  max. is not specified. The indication accuracy of B thermocouples in the  $400$  to  $800^\circ\text{C}$  range is  $\pm 3^\circ\text{C}$  max. The indication accuracy of the R and S thermocouples at a temperature of  $200^\circ\text{C}$  max. is  $\pm 3^\circ\text{C} \pm 1$  digit max. The indication accuracy of W thermocouples is  $\pm 0.3\%$  of PV or  $\pm 3^\circ\text{C}$ , whichever is greater,  $\pm 1$  digit max.

The indication accuracy of PL II thermocouples is  $\pm 0.3\%$  of PV or  $\pm 2^\circ\text{C}$ , whichever is greater,  $\pm 1$  digit max.

\*2. Ambient temperature:  $-10^\circ\text{C}$  to  $23^\circ\text{C}$  to  $55^\circ\text{C}$ , Voltage range:  $-15\%$  to  $10\%$  of rated voltage

\*3. K thermocouple at  $-100^\circ\text{C}$  max.:  $\pm 10^\circ\text{C}$  max.

\*4. External communications (RS-232C, RS-485, or RS-422) and cable communications for the Setup Tool can be used at the same time.



## USB-Serial Conversion Cable

Applicable OS	Windows 2000, XP, or Vista
Applicable software	Thermo Mini, CX-Thermo version 4.0 or higher
Applicable models	E5AN/E5EN/E5CN/E5CN-U/ E5AN-H/E5EN-H/E5CN-H
USB interface standard	Conforms to USB Specification 1.1.
DTE speed	38400 bps
Connector specifications	Computer: USB (type A plug) Temperature Controller: Setup Tool port (on bottom of Controller)
Power supply	Bus power (Supplied from USB host controller.)
Power supply voltage	5 VDC
Current consumption	70 mA
Ambient operating temperature	0 to 55°C (with no condensation or icing)
Ambient operating humidity	10% to 80%
Storage temperature	-20 to 60°C (with no condensation or icing)
Storage humidity	10% to 80%
Altitude	2,000 m max.
Weight	Approx. 100 g

**Note:** A driver must be installed in the personal computer. Refer to installation information in the operation manual for the Conversion Cable.

## Communications Specifications

Transmission line connection method	RS-485, RS-422: Multipoint RS-232C: Point-to-point
Communications	RS-485 (two-wire, half duplex) RS-422 (four-wire, half duplex) or RS-232C
Synchronization method	Start-stop synchronization
Protocol	CompoWay/F, SYSWAY, or Modbus
Baud rate	1200, 2400, 4800, 9600, 19200, 38400, or 57600 bps
Transmission code	ASCII (CompoWay/F, SYSWAY) RTU (Modbus)
Data bit length *	7 or 8 bits
Stop bit length *	1 or 2 bits
Error detection	Vertical parity (none, even, odd) Frame check sequence (FCS) with SYSWAY Block check character (BCC) with CompoWay/F or CRC-16 Modbus
Flow control	None
Interface	RS-485, RS-422, or RS-232C
Retry function	None
Communications buffer	217 bytes
Communications response wait time	0 to 99 ms Default: 20 ms

**Note:** The baud rate, data bit length, stop bit length, and vertical parity can be individually set using the Communications Setting Level.

## Current Transformer (Order Separately) Ratings

Dielectric strength	1,000 VAC for 1 min
Vibration resistance	50 Hz, 98 m/s <sup>2</sup>
Weight	E54-CT1: Approx. 11.5 g, E54-CT3: Approx. 50 g
Accessories (E54-CT3 only)	Armatures (2) Plugs (2)

## USB-Infrared Conversion Cable

Applicable OS	Windows 2000, XP, or Vista
Applicable software	Thermo Mini, CX-Thermo version 4.0 or higher
Applicable models	E5AN-H/E5EN-H
USB interface standard	Conforms to USB Specification 1.1.
DTE speed	38400 bps
Connector specifications	Computer: USB (type A plug) Temperature Controller: Infrared port (on front of Controller)
Power supply	Bus power (Supplied from USB host controller.)
Power supply voltage	5 VDC
Current consumption	80 mA
Ambient operating temperature	0 to 55°C (with no condensation or icing)
Ambient operating humidity	10% to 80%
Storage temperature	-20 to 60°C (with no condensation or icing)
Storage humidity	10% to 80%
Altitude	2,000 m max.
Weight	Approx. 130 g (with mounting adaptor)

**Note:** A driver must be installed in the personal computer. Refer to installation information in the operation manual for the Conversion Cable.

## Heater Burnout Alarms, SSR Failure Alarms, and Heater Overcurrent Alarms

CT input (for heater current detection)	Models with detection for single-phase heaters: One input Models with detection for single-phase or three-phase heaters: Two inputs
Maximum heater current	50 A AC
Input current indication accuracy	±5% FS ±1 digit max.
Heater burnout alarm setting range *1	0.1 to 49.9 A (in units of 0.1 A) Minimum detection ON time: 100 ms
SSR failure alarm setting range *2	0.1 to 49.9 A (in units of 0.1 A) Minimum detection OFF time: 100 ms
Heater overcurrent alarm setting range *3	0.1 to 49.9 A (in units of 0.1 A) Minimum detection ON time: 100 ms

- \*1. For heater burnout alarms, the heater current will be measured when the control output is ON, and the output assigned to the alarm 1 function will turn ON if the heater current is lower than the set value (i.e., heater burnout detection current value).
- \*2. For SSR failure alarms, the heater current will be measured when the control output is OFF, and the output assigned to the alarm 1 function will turn ON if the heater current is higher than the set value (i.e., SSR failure detection current value).
- \*3. For heater overcurrent alarms, the heater current will be measured when the control output is ON, and the output assigned to the alarm 1 function will turn ON if the heater current is higher than the set value (i.e., heater overcurrent detection current value).

### Electrical Life Expectancy Curve for Relays (Reference Values)

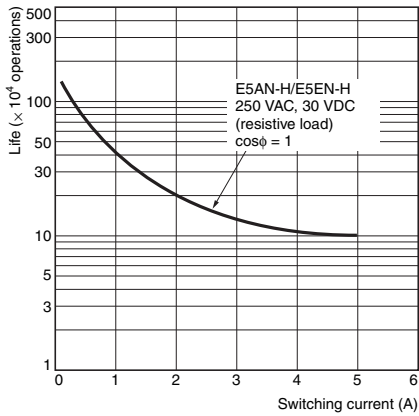

### SSR Outputs (OUT1/OUT2) Ratings

- Rated load voltage: 75 to 250 VAC
- Rated load current: 1 A (resistive load)

**Note:** 1. The load current must be within the derating curve.  
 2. There is no zero-cross function.

### Derating Curve for SSR Outputs (Reference Values)

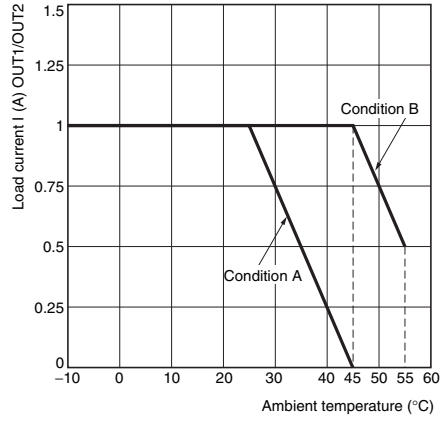

Condition A: SSR outputs 100% ON

Condition B: SSR outputs 50% ON with 2-s control cycle

# External Connections

- A voltage output (control output 1, for driving SSR) is not electrically insulated from the internal circuits. When using a grounding thermocouple, do not connect any of the control output terminals to ground. If the control output terminals are connected to ground, errors will occur in the measured temperature values as a result of leakage current. The voltage output (control output 2, for driving SSR) has basic insulation provided for the internal circuit

## Controllers

## Option Units

- 100 to 240 VAC
- 24 VAC/VDC (no polarity)

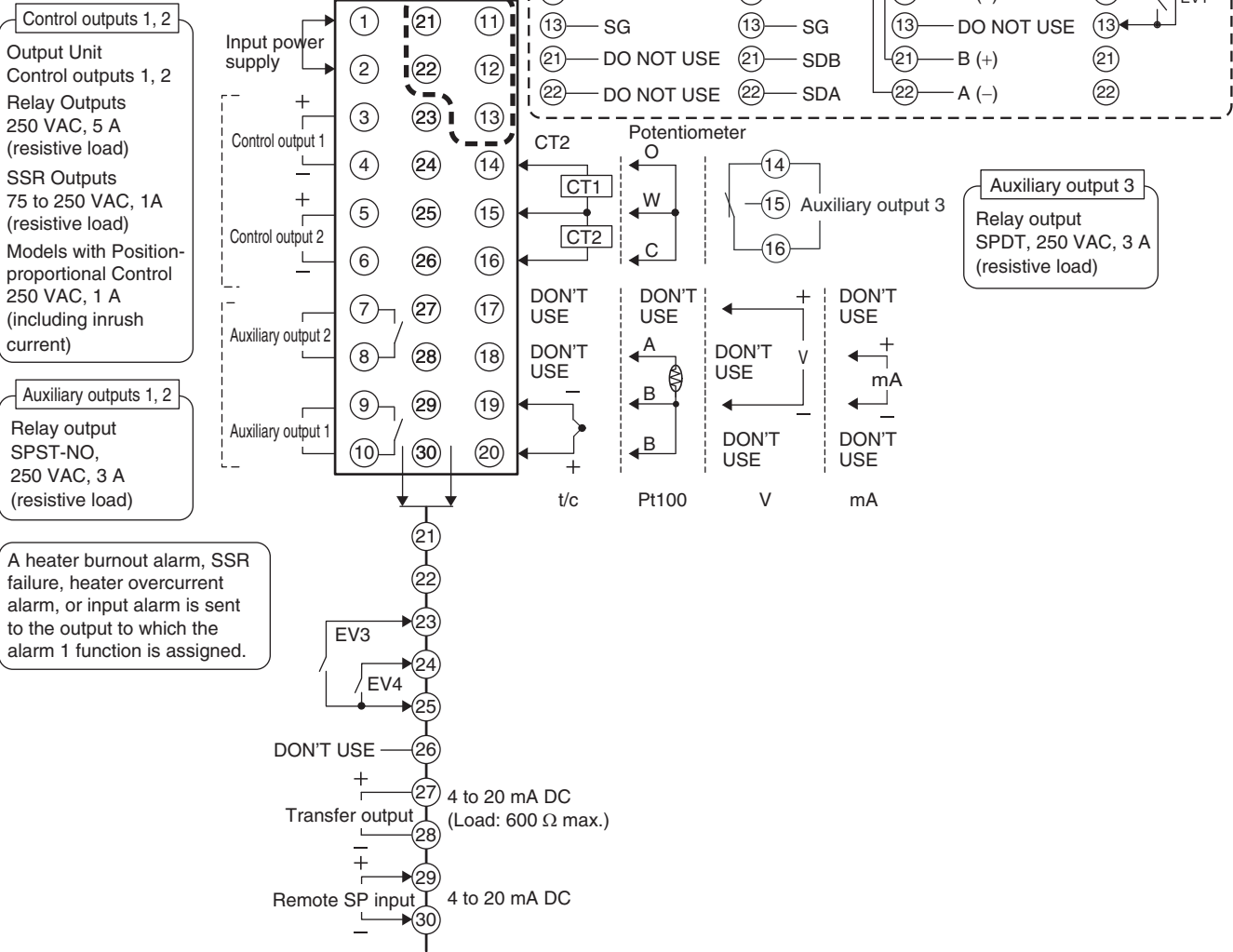

# Nomenclature

## E5AN-H

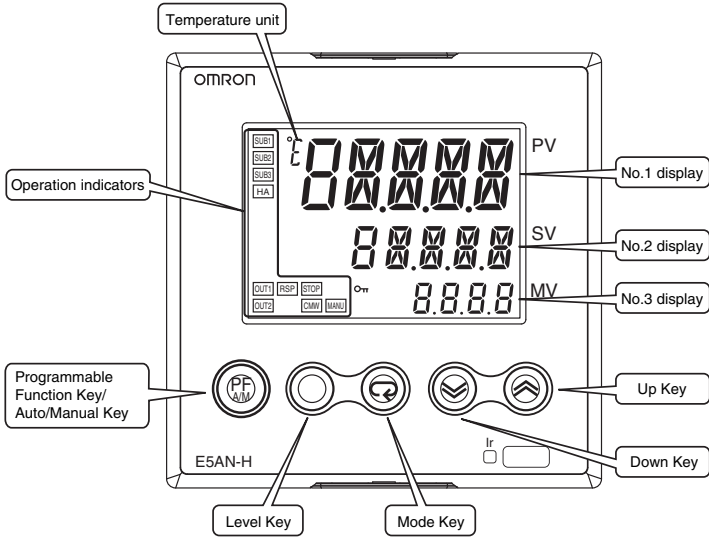

## E5EN-H

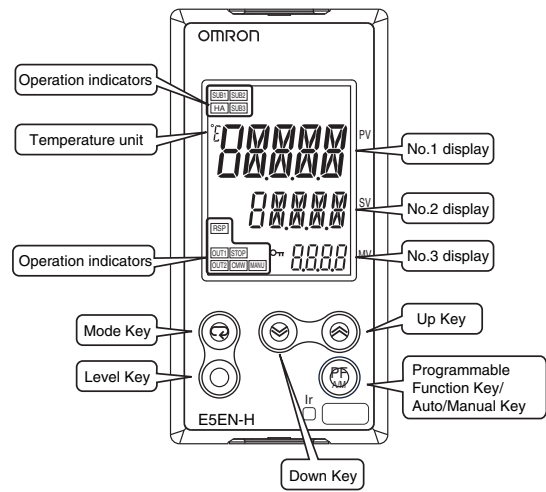

# Dimensions

(Unit: mm)

## E5AN-H

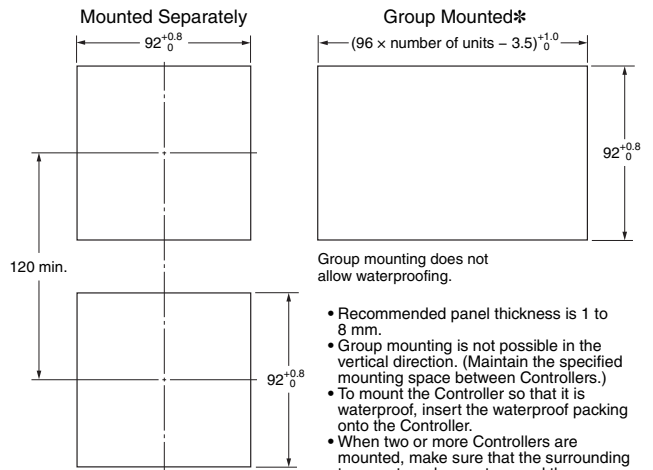
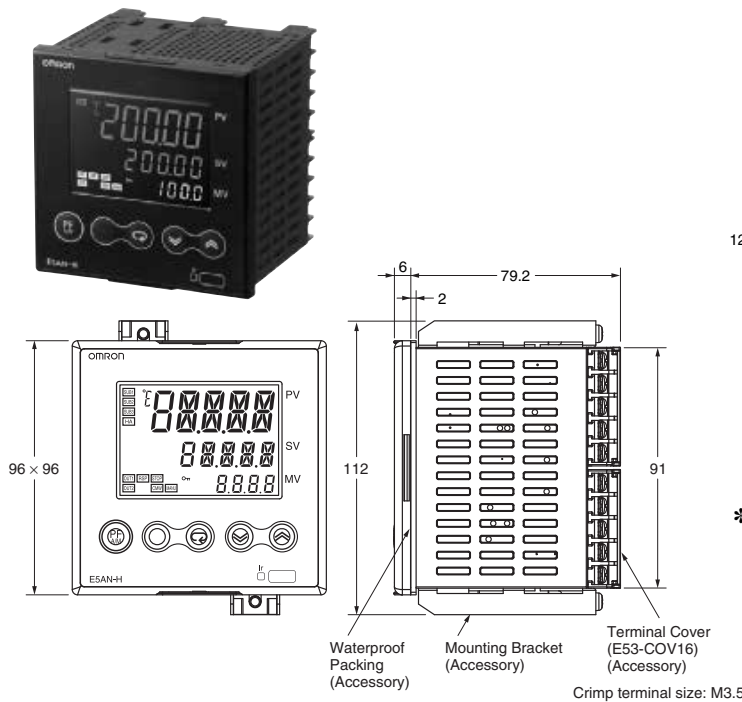

\* Group mounting is not possible if an SSR output is used for control output 1 or 2 and the E53-C3N or E53-C3DN Output Unit is used. For these combinations, maintain the following mounting space between Controllers.

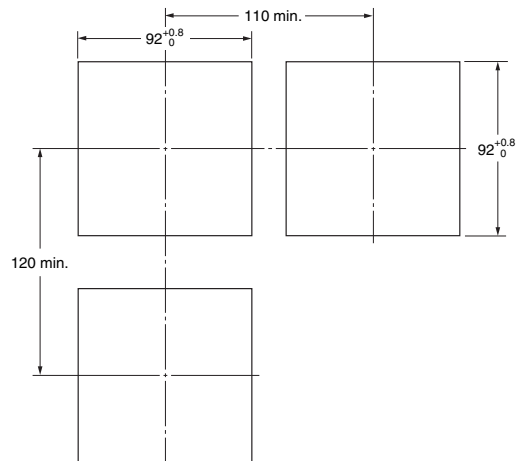

E5EN-H

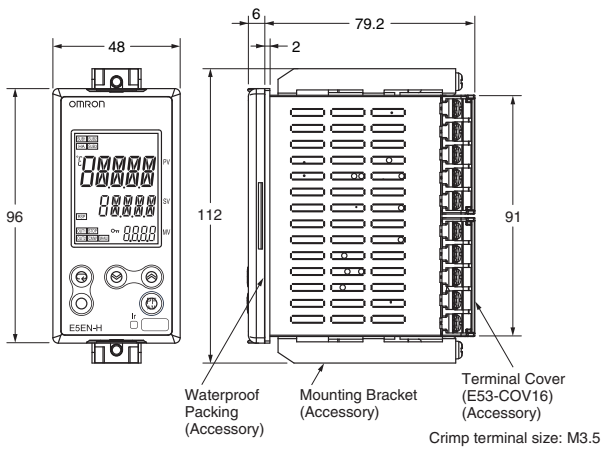

Mounted Separately

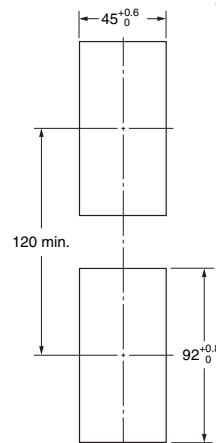

Group Mounted\*

$(48 \times \text{number of units} - 2.5)^{+1.0}_0$

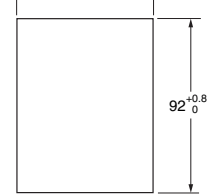

Group mounting does not allow waterproofing.

- Recommended panel thickness is 1 to 8 mm.
- Group mounting is not possible in the vertical direction. (Maintain the specified mounting space between Controllers.)
- When two or more Controllers are mounted, make sure that the surrounding temperature does not exceed the allowable operating temperature specified in the specifications.

\* Group mounting is not possible if an SSR output is used for control output 1 or 2 and the E53-C3N or E53-C3DN Output Unit is used. For these combinations, maintain the following mounting space between Controllers.

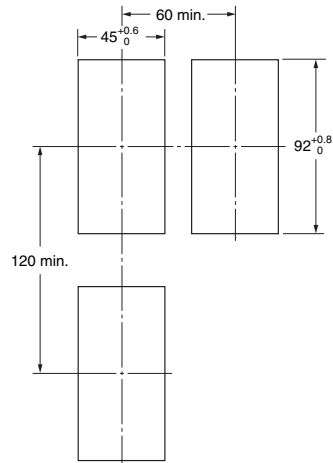

Accessories (Order Separately)

USB-Infrared Conversion Cable

E58-CIFIR

USB-Infrared Conversion Cable

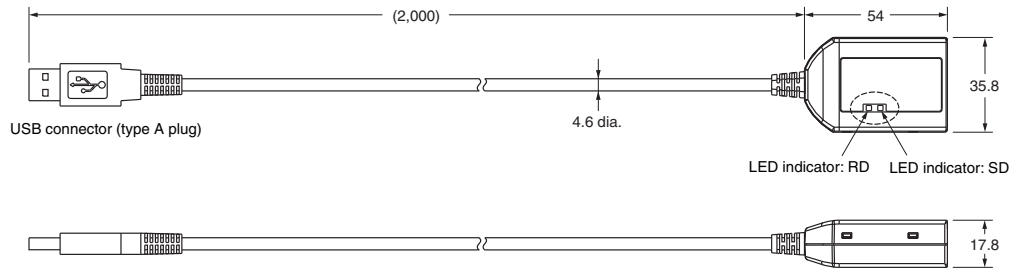

Mounting Adapter



With Mounting Adapter Connected

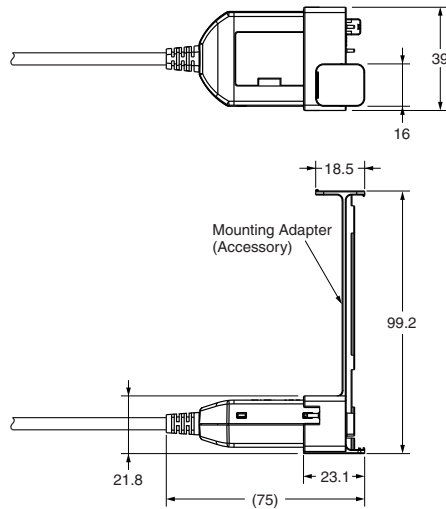

USB-Serial Conversion Cable

E58-CIFQ1

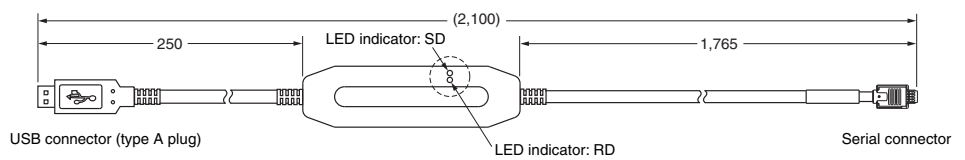
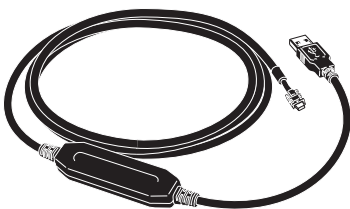

Terminal Covers

E53-COV16 (Six Covers provided.)

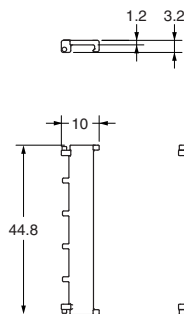
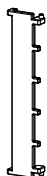

**Waterproof Packing**

**Y92S-P4 (for DIN 96 × 96)**

**Y92S-P5 (for DIN 48 × 96)**

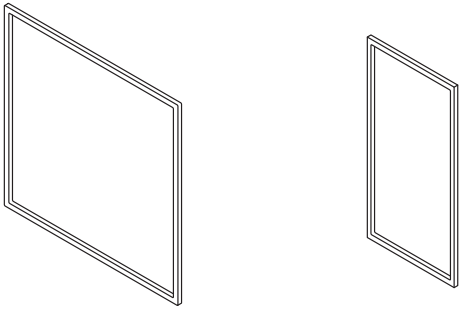

Order the Waterproof Packing separately if it becomes lost or damaged.  
 The Waterproof Packing can be used to achieve an IP66 degree of protection.  
 (Deterioration, shrinking, or hardening of the waterproof packing may occur depending on the operating environment. Therefore, periodic replacement is recommended to ensure the level of waterproofing specified in IP66. The time for periodic replacement depends on the operating environment. Be sure to confirm this point at your site. Consider one year a rough standard. OMRON shall not be liable for the level of water resistance if the customer does not perform periodic replacement.)  
 The Waterproof Packing does not need to be attached if a waterproof structure is not required.

**Current Transformers**

**E54-CT1**

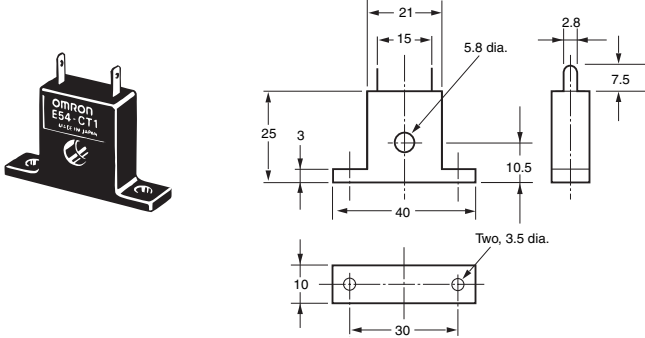

**E54-CT1 Thru-current (I<sub>o</sub>) vs. Output Voltage (E<sub>o</sub>) (Reference Values)**

Maximum continuous heater current: 50 A (50/60 Hz)  
 Number of windings: 400±2  
 Winding resistance: 18±2 Ω

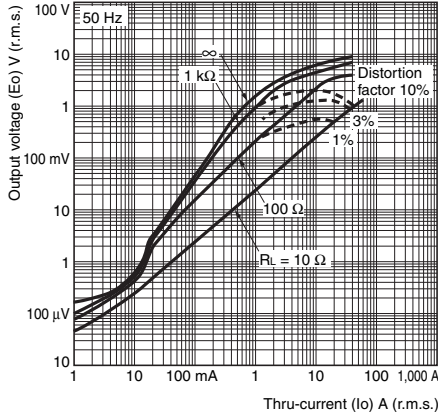

**E54-CT3**

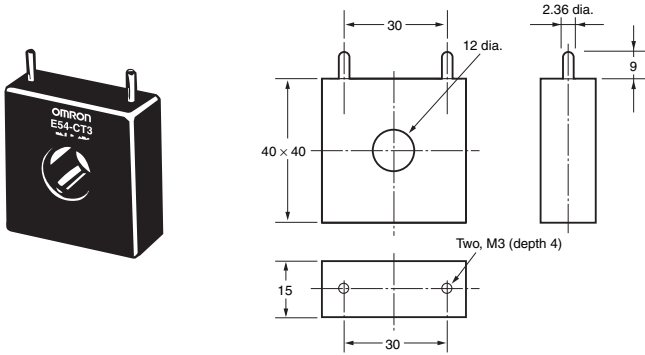

**E54-CT3 Thru-current (I<sub>o</sub>) vs. Output Voltage (E<sub>o</sub>) (Reference Values)**

Maximum continuous heater current: 120 A (50/60 Hz)  
 (Maximum continuous heater current for an OMRON Temperature Controller is 50 A.)  
 Number of windings: 400±2  
 Winding resistance: 8±0.8 Ω

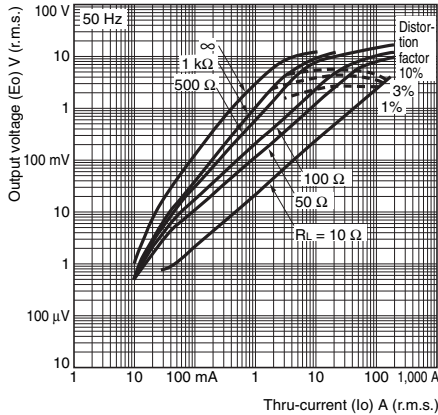

**E54-CT3 Accessory**

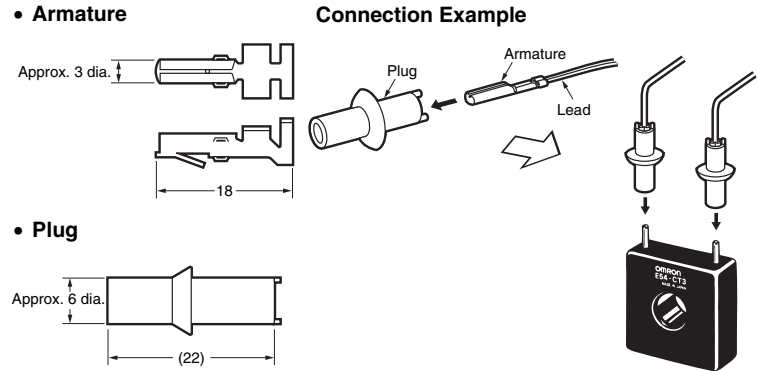





# Operation

## E5EN-H / E5AN-H

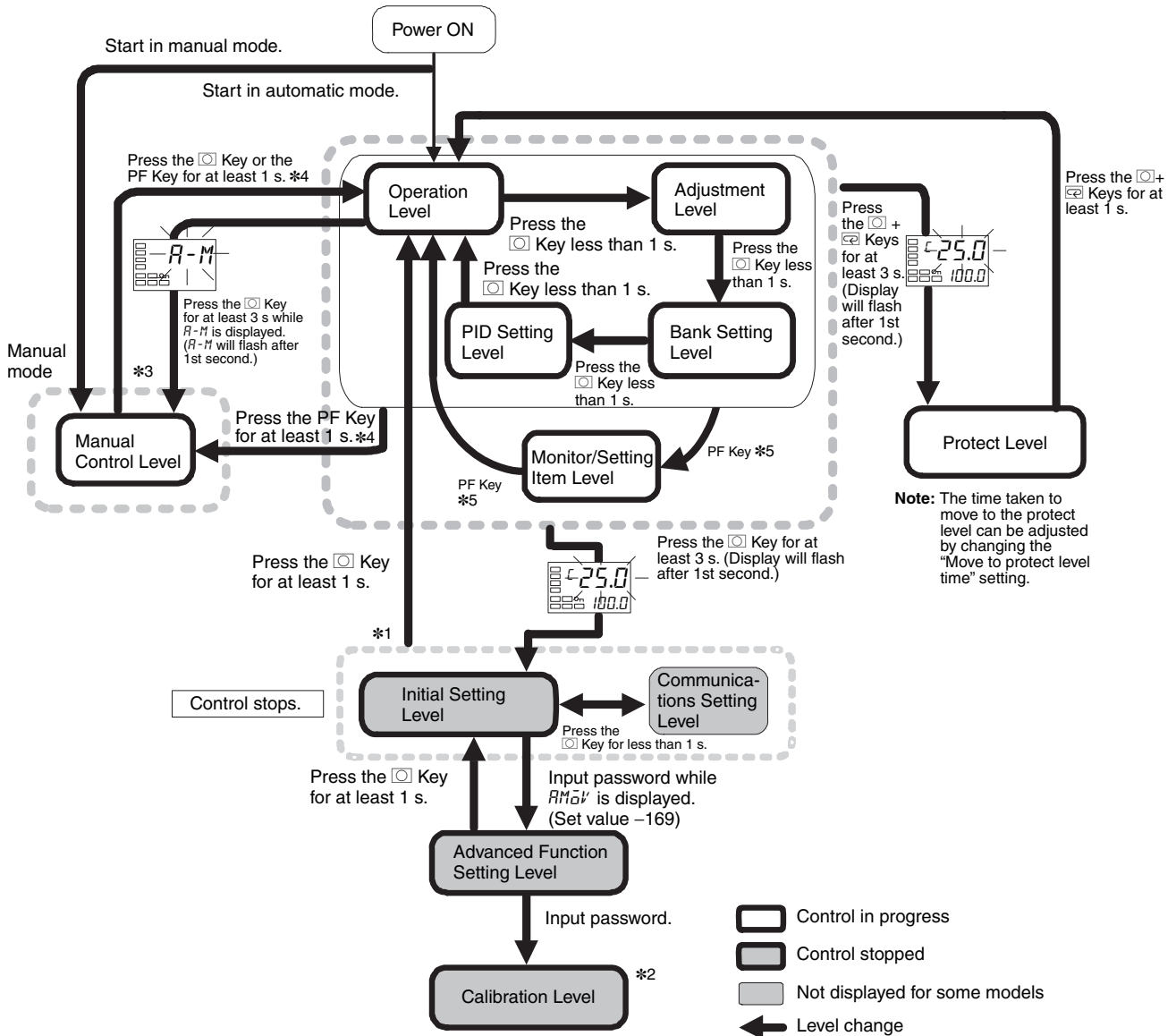

- \*1. You can return to the operation level by executing a software reset.
- \*2. It is not possible to move to other levels from the calibration level by operating the keys on the front panel. It can be done only by first turning OFF the power.
- \*3. From the manual control level, key operations can be used to move to the operation level only.
- \*4. When the PF Setting parameter is set to A-M for a Controller with a PF Key (E5AN-H/E5EN-H).
- \*5. When the PF Setting parameter is set to PFDP for a Controller with a PF Key (E5AN-H/E5EN-H)

## Error Displays (Troubleshooting)

When an error occurs, the No.1 display shows the error code. Take necessary measure according to the error code, referring the table below.

No.1 display	Meaning	Action	Status at error	
			Control output	Alarm output
$SERR$ (S. Err)	Input error *	Check the wiring of inputs for miswiring, disconnections, and short-circuits and check the input type.	OFF	Operates as above the upper limit.
$E333$ (E333)	A/D converter error	Turn the power OFF then back ON again. If the display remains the same, the controller must be repaired. If the display is restored to normal, then a probable cause can be external noise affecting the control system. Check for external noise.	OFF	OFF
$E111$ (E111)	Memory error	Turn the power OFF then back ON again. If the display remains the same, the controller must be repaired. If the display is restored to normal, then a probable cause can be external noise affecting the control system. Check for external noise.	OFF	OFF

**Note:** If the input value exceeds the display limit (-19999 to 32400), though it is within the control range,  $\square\square\square\square$  will be displayed under -19999 and  $\square\square\square\square$  above 32400. Under these conditions, control output and alarm output will operate normally. For details on the control range, refer to the *E5CN-H/E5AN-H/E5EN-H Digital Controllers User's Manual Advanced Type* (Cat. No. H157).

\* These errors are displayed only when the PV/SP is displayed. Errors are not displayed for other displays.

**E5EN-H / E5AN-H**

Some parameters are not displayed depending on the model of the Controller and parameter settings.

For details, refer to the *E5CN-H/E5AN-H/ E5EN-H Digital Controllers User's Manual Advanced Type* (Cat. No. H157).

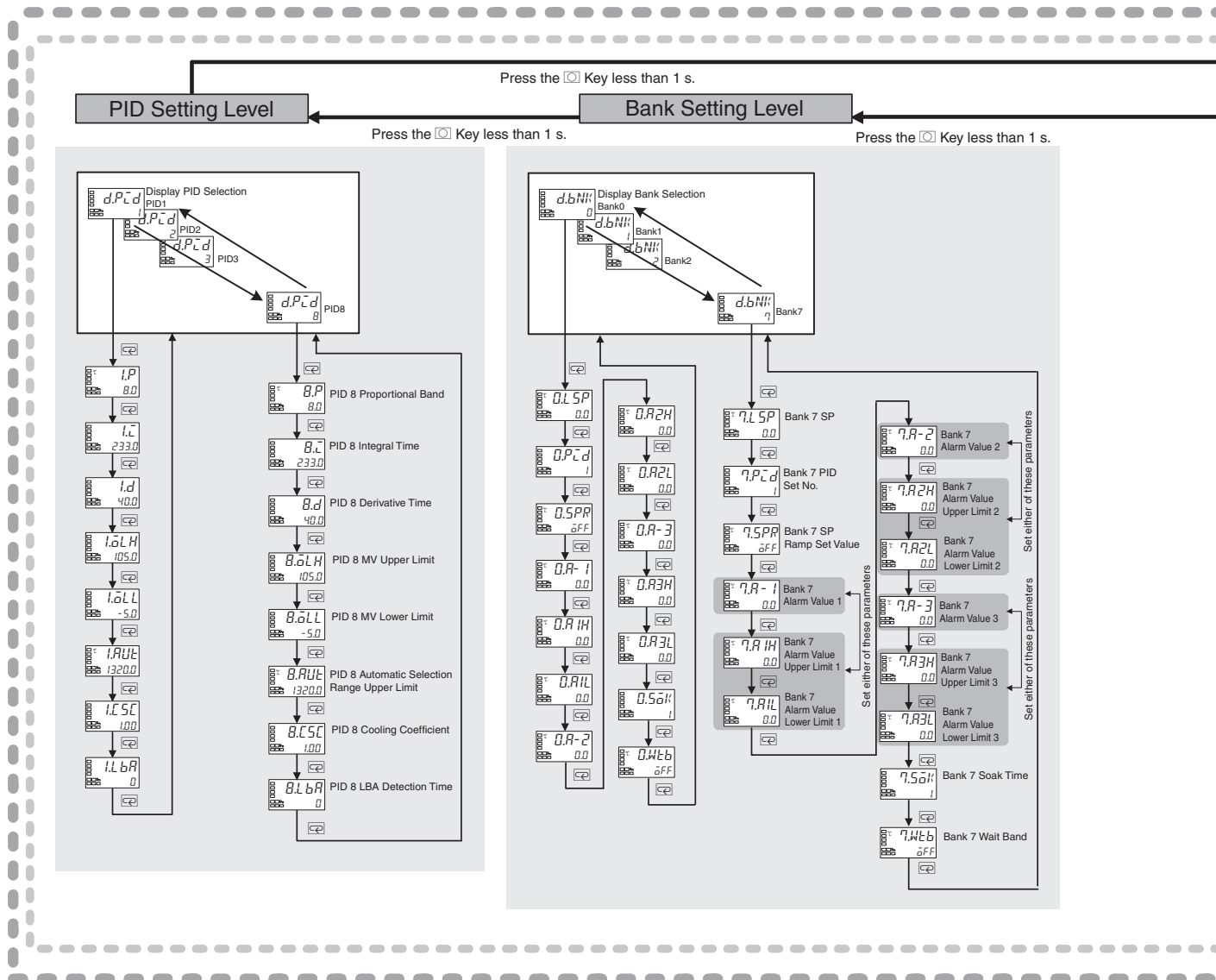
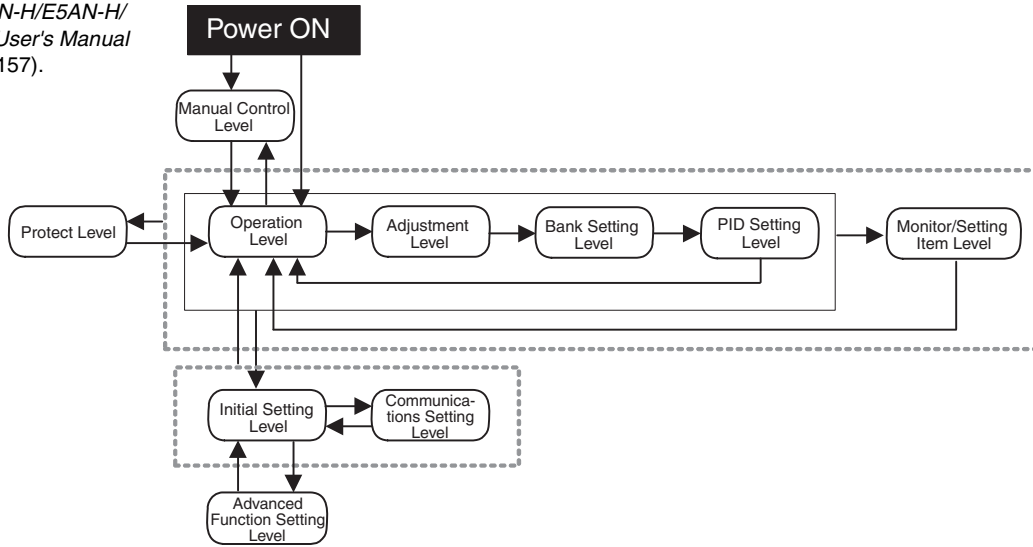

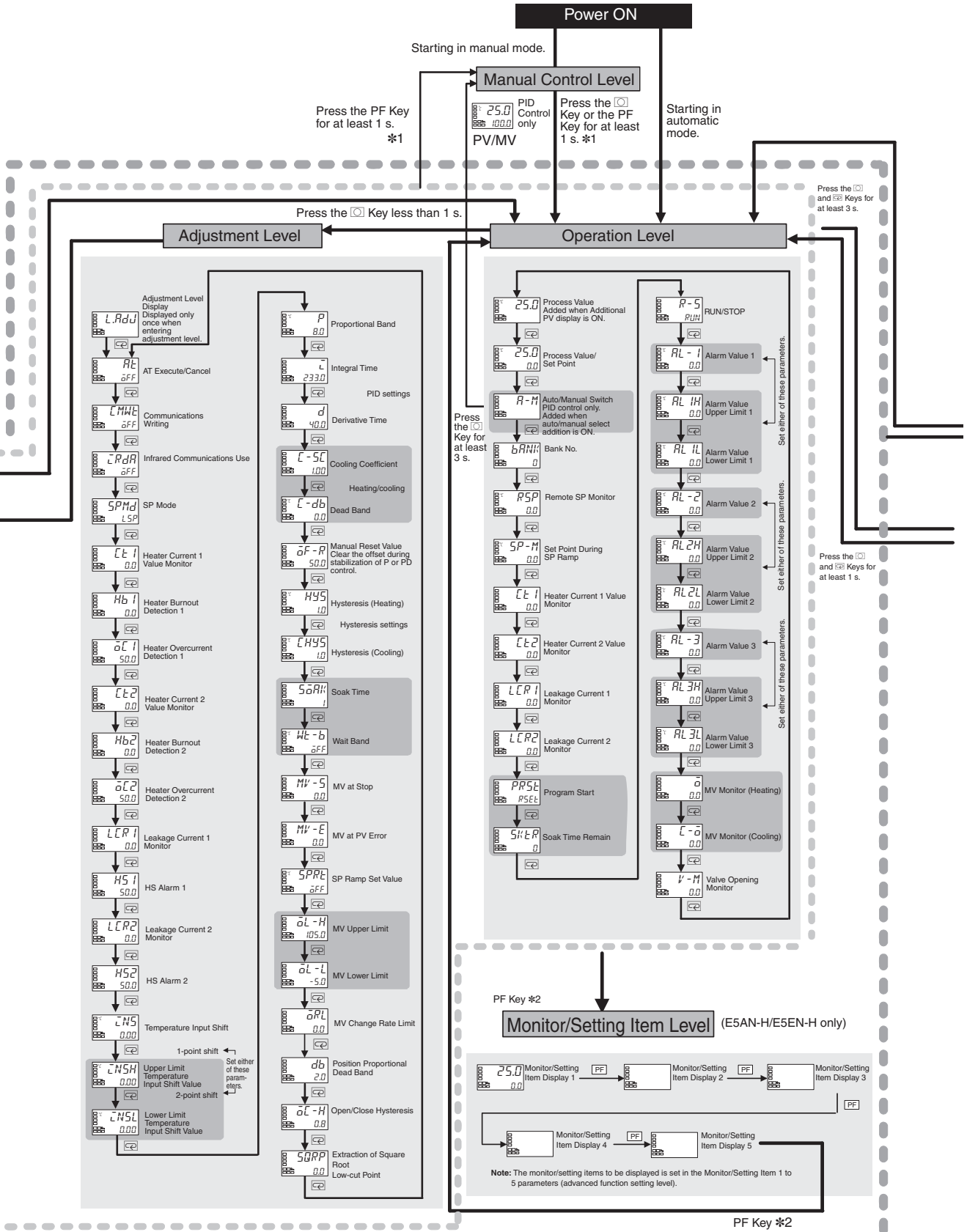

\*1. When the PF Setting parameter is set to A-M for a Controller with a PF Key (E5AN-H/E5EN-H).  
 \*2. When the PF Setting parameter is set to PFD for a Controller with a PF Key (E5AN-H/E5EN-H).

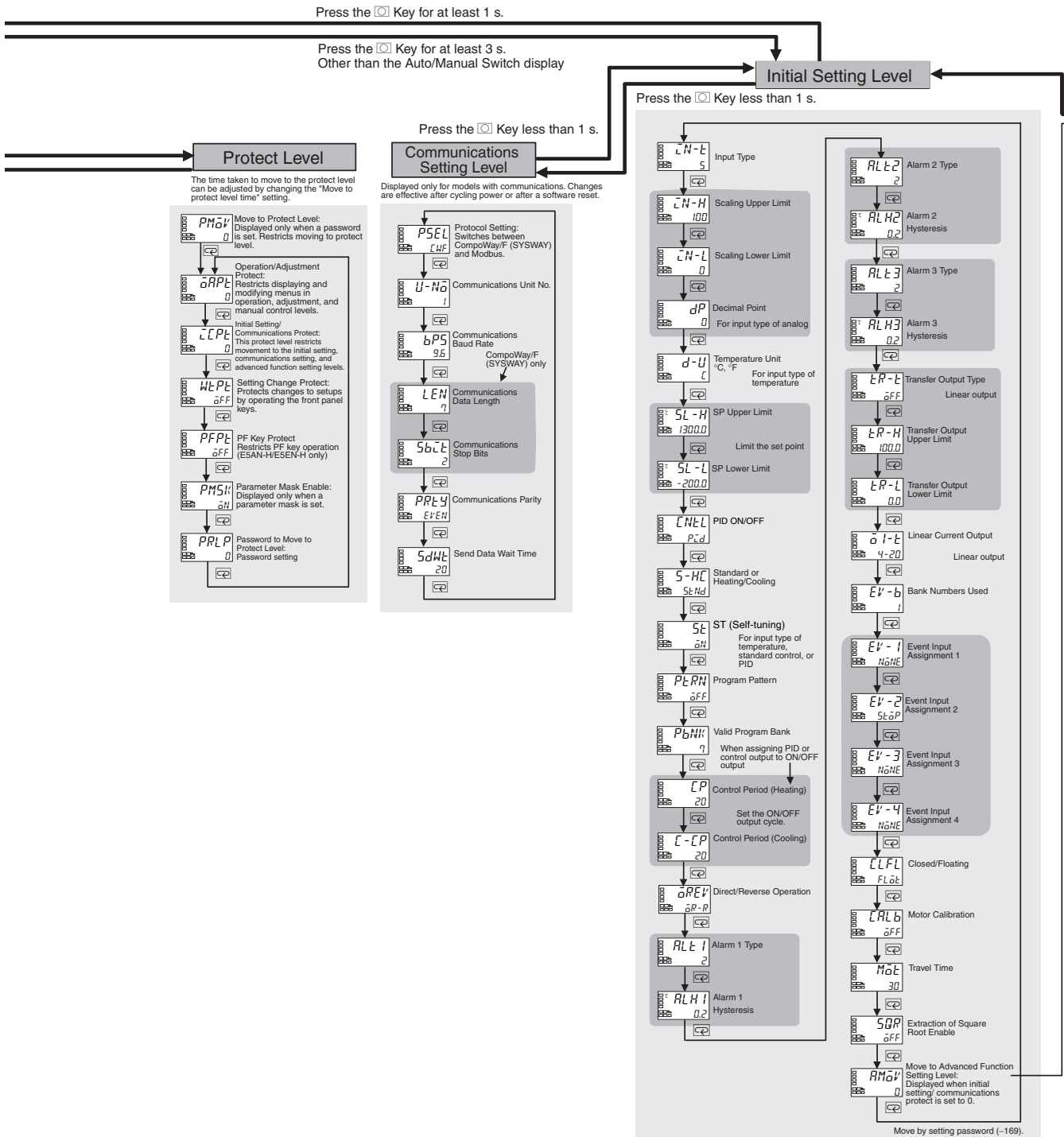

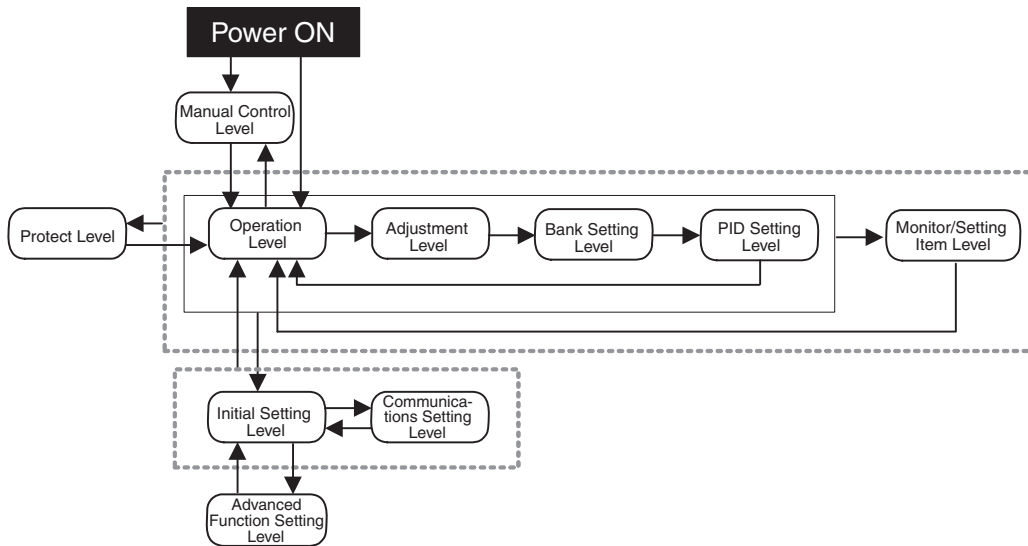

Press the Key for at least 1 s.

**Advanced Function Setting Level**

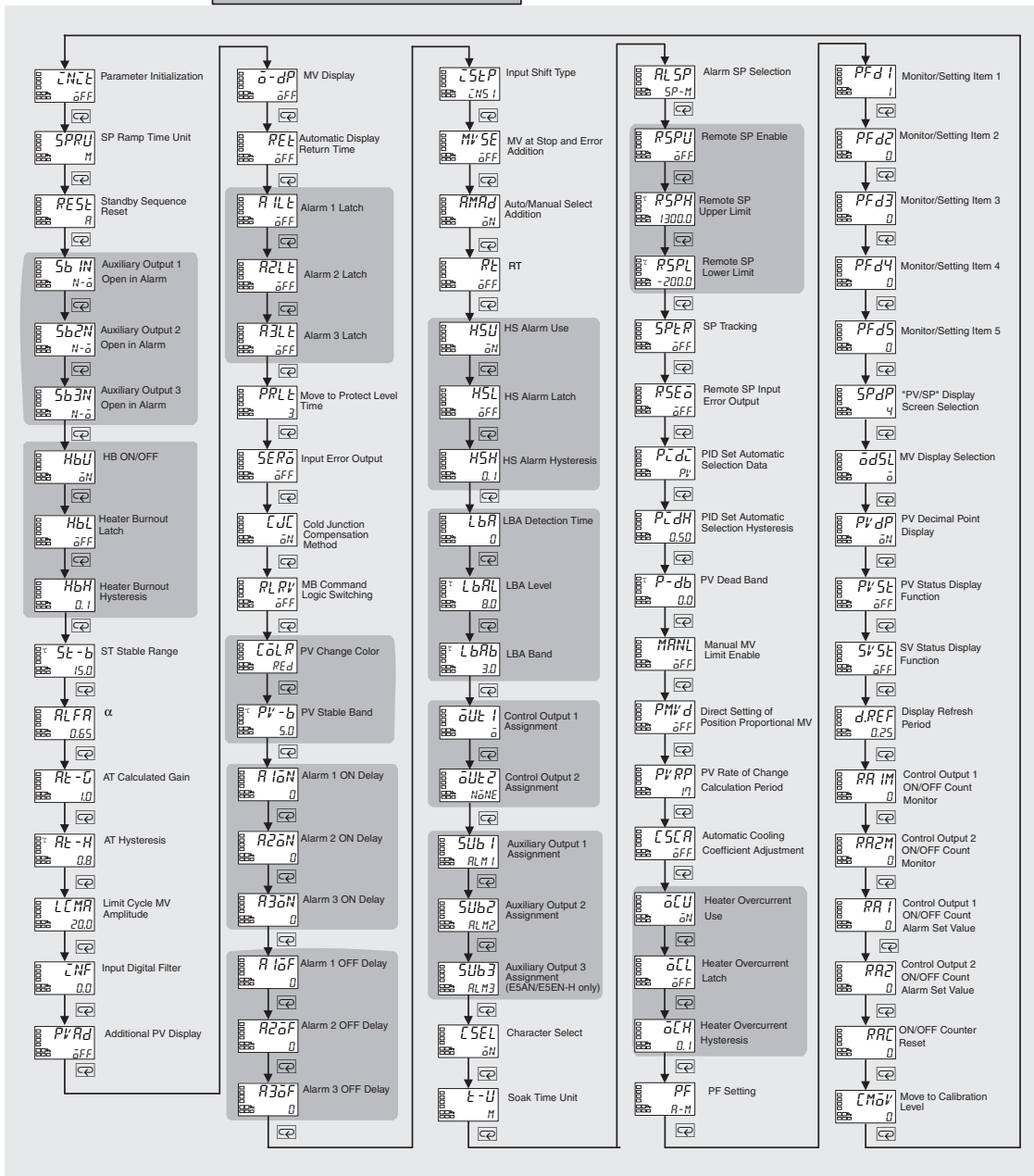

## Safety Precautions

### CAUTION

Do not touch the terminals while power is being supplied. Doing so may occasionally result in minor injury due to electric shock.



Do not allow pieces of metal, wire clippings, or fine metallic shavings or filings from installation to enter the product. Doing so may occasionally result in electric shock, fire, or malfunction.



Do not use the product where subject to flammable or explosive gas. Otherwise, minor injury from explosion may occasionally occur.



Do not leave the cable for the Support Software connected to the product. Malfunction may occur due to noise in the cable.



Do not use the Temperature Controller or Conversion Cable if it is damaged. Doing so may occasionally result in minor electric shock or fire.



Never disassemble, modify, or repair the product or touch any of the internal parts. Minor electric shock, fire, or malfunction may occasionally occur.



#### CAUTION - Risk of Fire and Electric Shock

- This product is UL listed as Open Type Process Control Equipment. It must be mounted in an enclosure that does not allow fire to escape externally.
- More than one disconnect switch may be required to de-energize the equipment before servicing the product.
- Signal inputs are SELV, limited energy. \*1
- Caution: To reduce the risk of fire or electric shock, do not interconnect the outputs of different Class 2 circuits. \*2



If the output relays are used past their life expectancy, contact fusing or burning may occasionally occur. Always consider the application conditions and use the output relays within their rated load and electrical life expectancy. The life expectancy of output relays varies considerably with the output load and switching conditions.



Tighten the terminal screws to between 0.74 and 0.90 N·m. \*3 Loose screws may occasionally result in fire.



Set the parameters of the product so that they are suitable for the system being controlled. If they are not suitable, unexpected operation may occasionally result in property damage or accidents.



A malfunction in the product may occasionally make control operations impossible or prevent alarm outputs, resulting in property damage. To maintain safety in the event of malfunction of the product, take appropriate safety measures, such as installing a monitoring device on a separate line.



A semiconductor is used in the output section of long-life relays. If excessive noise or surge is impressed on the output terminals, a short-circuit failure is likely to occur. If the output remains shorted, fire will occur due to overheating of the heater or other cause. Take measures in the overall system to prevent excessive temperature increase and to prevent fire from spreading.



Do not allow pieces of metal or wire cuttings to get inside the cable connector for the Support Software. Failure to do so may occasionally result in minor electric shock, fire, or damage to equipment.



Do not allow dust and dirt to collect between the pins in the connector on the Conversion Cable. Failure to do so may occasionally result in fire.



When inserting the body of the Temperature Controller into the case, confirm that the hooks on the top and bottom are securely engaged with the case. If the body of the Temperature Controller is not inserted properly, faulty contact in the terminal section or reduced water resistance may occasionally result in fire or malfunction.



When connecting the Control Output Unit to the socket, press it in until there is no gap between the Control Output Unit and the socket. Otherwise contact faults in the connector pins may occasionally result in fire or malfunction.



- \*1. An SELV circuit is one separated from the power supply with double insulation or reinforced insulation, that does not exceed 30 V r.m.s. and 42.4 V peak or 60 VDC.
- \*2. A class 2 power supply is one tested and certified by UL as having the current and voltage of the secondary output restricted to specific levels.
- \*3. The tightening torque for E5CN-U is 0.5 N·m.

## Precautions for Safe Use

Be sure to observe the following precautions to prevent malfunction or adverse affects on the performance or functionality of the product. Not doing so may occasionally result in faulty operation.

- This product is specifically designed for indoor use only. Do not use this product in the following places:
  - Places directly subject to heat radiated from heating equipment.
  - Places subject to splashing liquid or oil atmosphere.
  - Places subject to direct sunlight.
  - Places subject to dust or corrosive gas (in particular, sulfide gas and ammonia gas).
  - Places subject to intense temperature change.
  - Places subject to icing and condensation.
  - Places subject to vibration and large shocks.
- Use and store the product within the rated ambient temperature and humidity. Gang-mounting two or more Temperature Controllers, or mounting Temperature Controllers above each other may cause heat to build up inside the Temperature Controllers, which will shorten their service life. In such a case, use forced cooling by fans or other means of air ventilation to cool down the Temperature Controllers.
- To allow heat to escape, do not block the area around the product. Do not block the ventilation holes on the product.
- Be sure to wire properly with correct polarity of terminals.
- Use the specified size (M3.5, width 7.2 mm or less) crimped terminals for wiring. To connect bare wires to the terminal block, use stranded or solid copper wires with a gage of AWG24 to AWG14 (equal to a cross-sectional area of 0.205 to 2.081 mm<sup>2</sup>). (The stripping length is 5 to 6 mm.) Up to two wires of the same size and type or two crimp terminals can be inserted into a single terminal.
- Do not wire the terminals that are not used.
- To avoid inductive noise, keep the wiring for the product's terminal block away from power cables carry high voltages or large currents. Also, do not wire power lines together with or parallel to product wiring. Using shielded cables and using separate conduits or ducts is recommended. Attach a surge suppressor or noise filter to peripheral devices that generate noise (in particular, motors, transformers, solenoids, magnetic coils, or other equipment that have an inductance component). When a noise filter is used at the power supply, first check the voltage or current, and attach the noise filter as close as possible to the product. Allow as much space as possible between the product and devices that generate powerful high frequencies (high-frequency welders, high-frequency sewing machines, etc.) or surge.
- Use this product within the rated load and power supply.
- Make sure that the rated voltage is attained within two seconds of turning ON the power using a switch or relay contact. If the voltage is applied gradually, the power may not be reset or output malfunctions may occur.
- Make sure that the Temperature Controller has 30 minutes or more to warm up after turning ON the power before starting actual control operations to ensure the correct temperature display.

11. When executing self-tuning, turn ON power to the load (e.g., heater) at the same time as or before supplying power to the product. If power is turned ON to the product before turning ON power to the load, self-tuning will not be performed properly and optimum control will not be achieved.
12. A switch or circuit breaker must be provided close to the product. The switch or circuit breaker must be within easy reach of the operator, and must be marked as a disconnecting means for this unit.
13. Always turn OFF the power supply before pulling out the interior of the product, and never touch nor apply shock to the terminals or electronic components. When inserting the interior of the product, do not allow the electronic components to touch the case.
14. Do not use paint thinner or similar chemical to clean with. Use standard grade alcohol.
15. Design the system (e.g., control panel) considering the 2 seconds of delay that the product's output to be set after power ON.
16. The output may turn OFF when shifting to certain levels. Take this into consideration when performing control.
17. The number of EEPROM write operations is limited. Therefore, use RAM write mode when frequently overwriting data during communications or other operations.
18. Always touch a grounded piece of metal before touching the Temperature Controller to discharge static electricity from your body.
19. Do not remove the terminal block. Doing so may result in failure or malfunction.
20. Control outputs (for driving SSR) that are voltage outputs are not isolated from the internal circuits. When using a grounded thermocouple, do not connect any of the control output terminals to ground. (Doing so may result in an unwanted circuit path, causing error in the measured temperature.)
21. When replacing the body of the Temperature Controller, check the condition of the terminals. If corroded terminals are used, contact failure in the terminals may cause the temperature inside the Temperature Controller to increase, possibly resulting in fire. If the terminals are corroded, replace the case as well.
22. Use suitable tools when taking the Temperature Controller apart for disposal. Sharp parts inside the Temperature Controller may cause injury.
23. Before connecting an Output Unit, confirm the specifications and thoroughly read relevant information in the datasheet and manual for the Temperature Controller.
24. Check the orientation of the connectors on the Conversion Cable before connecting the Conversion Cable. Do not force a connector if it does not connect smoothly. Using excessive force may damage the connector.
25. Do not place heavy object on the Conversion Cable, bend the cable past its natural bending radius, or pull on the cable with undue force.
26. Do not connect or disconnect the Conversion Cable while communications are in progress. Product faults or malfunction may occur.
27. Make sure that the Conversion Cable's metal components are not touching the external power terminals.
28. Do not touch the connectors on the Conversion Cable with wet hands. Electrical shock may result.
29. Before using infrared communications, correctly attach the enclosed Mounting Adapter to the cable for the Support Software. When connecting the infrared port on the cable to the Support Software into the Adapter, insert the connector to the specified line. Communications may not be possible if the connector is not connected properly.

## Precautions for Correct Use

### Service Life

1. Use the product within the following temperature and humidity ranges:  
 Temperature: -10 to 55°C (with no icing or condensation)  
 Humidity: 25% to 85%  
 If the product is installed inside a control board, the ambient temperature must be kept to under 55°C, including the temperature around the product.
2. The service life of electronic devices like Temperature Controllers is determined not only by the number of times the relay is switched but also by the service life of internal electronic components. Component service life is affected by the ambient temperature: the higher the temperature, the shorter the service life and, the lower

the temperature, the longer the service life. Therefore, the service life can be extended by lowering the temperature of the Temperature Controller.

3. When two or more Temperature Controllers are mounted horizontally close to each other or vertically next to one another, the internal temperature will increase due to heat radiated by the Temperature Controllers and the service life will decrease. In such a case, use forced cooling by fans or other means of air ventilation to cool down the Temperature Controllers. When providing forced cooling, however, be careful not to cool down the terminals sections alone to avoid measurement errors.

### Measurement Accuracy

1. When extending or connecting the thermocouple lead wire, be sure to use compensating wires that match the thermocouple types.
2. When extending or connecting the lead wire of the platinum resistance thermometer, be sure to use wires that have low resistance and keep the resistance of the three lead wires the same.
3. Mount the product so that it is horizontally level.
4. If the measurement accuracy is low, check to see if input shift has been set correctly.

### Waterproofing

The degree of protection is as shown below. Sections without any specification on their degree of protection or those with IP□□ are not waterproof.

Front panel: IP66

Rear case: IP20, Terminal section: IP00

(E5CN-U: Front panel: IP50, rear case: IP20, terminals: IP00)

### Operating Precautions

1. It takes approximately two seconds for the outputs to turn ON from after the power supply is turned ON. Due consideration must be given to this time when incorporating Temperature Controllers in a sequence circuit.
2. When using self-tuning, turn ON power for the load (e.g., heater) at the same time as or before supplying power to the Temperature Controller. If power is turned ON for the Temperature Controller before turning ON power for the load, self-tuning will not be performed properly and optimum control will not be achieved.
3. When starting operation after the Temperature Controller has warmed up, turn OFF the power and then turn it ON again at the same time as turning ON power for the load. (Instead of turning the Temperature Controller OFF and ON again, switching from STOP mode to RUN mode can also be used.)
4. Avoid using the Controller in places near a radio, television set, or wireless installing. These devices can cause radio disturbances which adversely affect the performance of the Controller.

### Others

1. The disk that is included with the Conversion Cable is designed for a computer CD-ROM driver. Never attempt to play the disk in a general-purpose audio player.
2. Do not connect or disconnect the Conversion Cable connector repeatedly over a short period of time. The computer may malfunction.
3. After connecting the Conversion Cable to the computer, check the COM port number before starting communications. The computer requires time to recognize the cable connection. This delay does not indicate failure.
4. Do not connect the Conversion Cable through a USB hub. Doing so may damage the Conversion Cable.
5. Do not use an extension cable to extend the Conversion Cable length when connecting to the computer. Doing so may damage the Conversion Cable.
6. The E5AN-H/E5EN-H use the same port for communications through the infrared port and the Support Software port. Do not attempt to use communications through the Support Software port when the infrared port is being used.

## Mounting

### Mounting to a Panel

For waterproof mounting, waterproof packing must be installed on the Controller. Waterproofing is not possible when group mounting several Controllers. Waterproof packing is not necessary when there is no need for the waterproofing function.

#### E5EN/E5AN

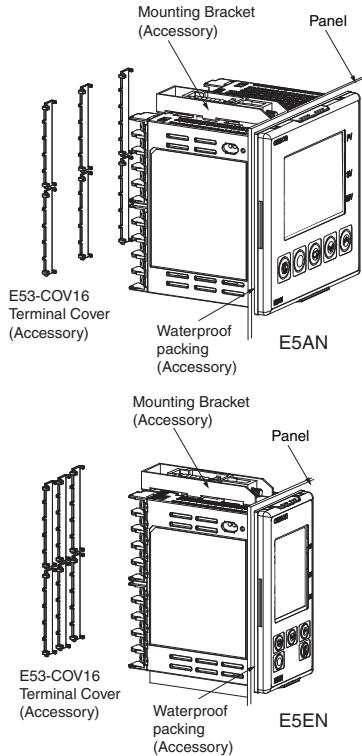

1. Insert the E5AN/E5EN into the square mounting hole in the panel (thickness: 1 to 8 mm). Attach the Mounting Brackets provided with the product to the mounting grooves on the top and bottom surfaces of the rear case.
2. Use a ratchet to alternately tighten the screws on the top and bottom Mounting Brackets little by little to maintain balance, until the ratchet turns freely.

### Mounting the Terminal Cover

#### E5AN/E5EN

Slightly bend the E53-COV16 Terminal Cover to attach it to the terminal block as shown in the following diagram. The Terminal Cover cannot be attached in the opposite direction.

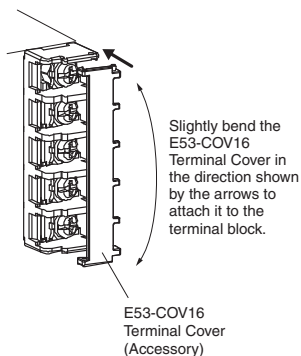

### Removing the Temperature Controller from the Case

The Temperature Controller can be removed from the case to perform maintenance without removing the terminal leads. This is possible for only the E5CN, E5AN, and E5EN, and not for the E5CN-U. Check the specifications of the case and Temperature Controller before removing the Temperature Controller from the case.

#### E5AN/E5EN

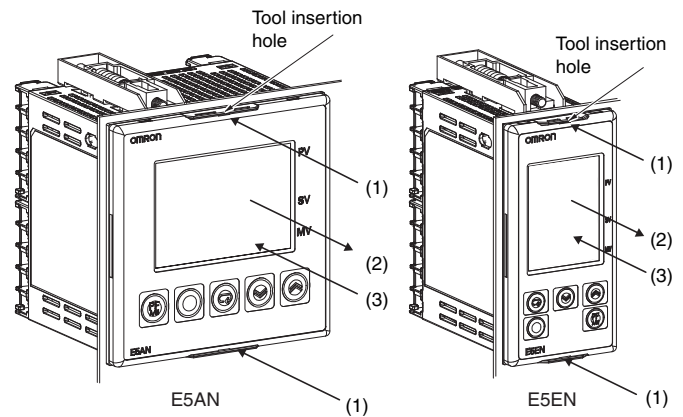

1. Insert a flat-blade screwdriver into the two tool insertion holes (one on the top and one on the bottom) to release the hooks.
2. Insert the flat-blade screwdriver in the gap between the front panel and rear case (two on the top and two on the bottom), and use it to pry and pull out the front panel slightly. Then, pull out on the front panel gripping both sides. Be sure not to impose excessive force on the panel.
3. When inserting the body of the Temperature Controller into the case, make sure the PCBs are parallel to each other, make sure that the sealing rubber is in place, and press the E5AN/E5EN toward the rear case until it snaps into position. While pressing the E5AN/E5EN into place, press down on the hooks on the top and bottom surfaces of the rear case so that the hooks securely lock in place. Make sure that electronic components do not come into contact with the case.

### Precautions when Wiring

- Separate input leads and power lines in order to prevent external noise.
- Use wires with a gage of AWG24 (cross-sectional area: 0.205 mm<sup>2</sup>) to AWG14 (cross-sectional area: 2.081 mm<sup>2</sup>) twisted-pair cable (stripping length: 5 to 6 mm).
- Use crimp terminals when wiring the terminals.
- Tighten the terminal screws to a torque of 0.74 to 0.90 N·m, however the terminal screws on the E5CN-U must be tightened to a torque of 0.5 N·m.
- Use the following types of crimp terminals for M3.5 screws.

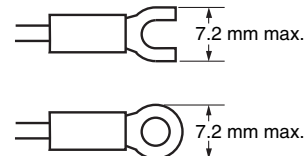

- Do not remove the terminal block. Doing so will result in malfunction or failure.





# Warranty and Application Considerations

## Read and Understand This Catalog

Please read and understand this catalog before purchasing the products. Please consult your OMRON representative if you have any questions or comments.

## Warranty and Limitations of Liability

### WARRANTY

OMRON's exclusive warranty is that the products are free from defects in materials and workmanship for a period of one year (or other period if specified) from date of sale by OMRON.

OMRON MAKES NO WARRANTY OR REPRESENTATION, EXPRESS OR IMPLIED, REGARDING NON-INFRINGEMENT, MERCHANTABILITY, OR FITNESS FOR PARTICULAR PURPOSE OF THE PRODUCTS. ANY BUYER OR USER ACKNOWLEDGES THAT THE BUYER OR USER ALONE HAS DETERMINED THAT THE PRODUCTS WILL SUITABLY MEET THE REQUIREMENTS OF THEIR INTENDED USE. OMRON DISCLAIMS ALL OTHER WARRANTIES, EXPRESS OR IMPLIED.

### LIMITATIONS OF LIABILITY

OMRON SHALL NOT BE RESPONSIBLE FOR SPECIAL, INDIRECT, OR CONSEQUENTIAL DAMAGES, LOSS OF PROFITS, OR COMMERCIAL LOSS IN ANY WAY CONNECTED WITH THE PRODUCTS, WHETHER SUCH CLAIM IS BASED ON CONTRACT, WARRANTY, NEGLIGENCE, OR STRICT LIABILITY.

In no event shall the responsibility of OMRON for any act exceed the individual price of the product on which liability is asserted.

IN NO EVENT SHALL OMRON BE RESPONSIBLE FOR WARRANTY, REPAIR, OR OTHER CLAIMS REGARDING THE PRODUCTS UNLESS OMRON'S ANALYSIS CONFIRMS THAT THE PRODUCTS WERE PROPERLY HANDLED, STORED, INSTALLED, AND MAINTAINED AND NOT SUBJECT TO CONTAMINATION, ABUSE, MISUSE, OR INAPPROPRIATE MODIFICATION OR REPAIR.

## Application Considerations

### SUITABILITY FOR USE

OMRON shall not be responsible for conformity with any standards, codes, or regulations that apply to the combination of products in the customer's application or use of the products.

Take all necessary steps to determine the suitability of the product for the systems, machines, and equipment with which it will be used.

Know and observe all prohibitions of use applicable to this product.

NEVER USE THE PRODUCTS FOR AN APPLICATION INVOLVING SERIOUS RISK TO LIFE OR PROPERTY WITHOUT ENSURING THAT THE SYSTEM AS A WHOLE HAS BEEN DESIGNED TO ADDRESS THE RISKS, AND THAT THE OMRON PRODUCTS ARE PROPERLY RATED AND INSTALLED FOR THE INTENDED USE WITHIN THE OVERALL EQUIPMENT OR SYSTEM.

## Disclaimers

### PERFORMANCE DATA

Performance data given in this catalog is provided as a guide for the user in determining suitability and does not constitute a warranty. It may represent the result of OMRON's test conditions, and the users must correlate it to actual application requirements. Actual performance is subject to the OMRON *Warranty and Limitations of Liability*.

### CHANGE IN SPECIFICATIONS

Product specifications and accessories may be changed at any time based on improvements and other reasons. Consult with your OMRON representative at any time to confirm actual specifications of purchased product.

### DIMENSIONS AND WEIGHTS

Dimensions and weights are nominal and are not to be used for manufacturing purposes, even when tolerances are shown.

### ALL DIMENSIONS SHOWN ARE IN MILLIMETERS.

To convert millimeters into inches, multiply by 0.03937. To convert grams into ounces, multiply by 0.03527.

Cat. No. H05E-EN-01B

**In the interest of product improvement, specifications are subject to change without notice.**

## OMRON EUROPE B.V.

Wegalaan 67-69,  
NL-2132 JD, Hoofddorp,  
The Netherlands

Phone: +31 23 568 13 00

Fax: +31 23 568 13 88

www.industrial.omron.eu

05/2008