

D3 Digital Positioner

Product Information





D3 Digital Positioner

General

The D3 is a digital valve positioner with exceptional features and benefits.

It's very simple to use and operate due to a large graphic display where all information is presented. Configuration is simply done from five large push buttons.

The zero bleed pneumatic relay offers savings due to very low air consumption.

Optional plug in modules offers limit switches, both mechanical, proximity and P+F inductive, 4–20 mA feedback and alarm with output function.

Communication via HART, Profibus PA or Foundation Fieldbus is possible. For the HART version of D3, a free of charge PC configurator is available.

IP66/NEMA 4X, 7 & 9

The strong, die-cast housing is treated with a powder epoxy, protecting the unit from corrosion and mechanical damage.

Additionally, the uniquely designed strut on the cover protects the graphic display.

The screw terminals for the electrical connection are located in an isolated and sealed housing to help protect the electronics if moisture should intrude the conduit.

Easy installation

Installation is simple and quick with split spindle design, a friction coupling for the feedback sensor and the great variety of mounting kits available from inventory to fit most actuators found on the market. The D3 is not orientation sensitive and mounts on both rotary and linear actuators.

A. Linear



B. Rotary



D3 Intrinsically Safe



D3 Explosion Proof



Feedback and Remote mount



Versions/Options

D3 Intrinsically Safe

The D3 is available in an intrinsically safe version for installation in hazardous areas. It features the same easy to use user interface for local configuration as D3. Communication with HART® or Profibus PA is possible. It features all benefits and options similar to the Standard D3 positioner, gauge block, local graphic LCD display and feedback option etc.

D3 Explosion Proof

The digital positioner D3 is available in explosion proof enclosure. It features the same easy to use user interface for local configuration as D3. Communication via HART®, Profibus PA or Foundation Fieldbus is possible.

Further features are gauge ports, local graphic LCD display.

D3 Remote Mounted

The D3 with remote mount is suitable for installations in severe applications e.g. heavy vibrations, high or low temperature corrosive environment, difficult of access.

A flat or dome style indicator can be fitted on the feedback box installed on the actuator. Max recommended distance between D3 and remote unit is 5 m.

D3 270°

D3 up to 270° for extended travel range. All PMV D3 versions are available with a 270° option.

Feedback + Alarm plug in module

Optional plug in feedback modules offer limit switch function; select between mechanical or proximity SPDT switches or P+F inductive sensors.

A 4-20 mA position feedback sensor is available as well as an alarm function for deviation, limit and temperature.



Fail Freeze

This special version offers the unique feature of upon loss of input signal the D3 will fail in last position, a function that is highly valued for dampers or other critical applications.

Pressure sensors

Optional on-board pressure sensors and D3 offers you possibility to utilize the full power of ValveSight software from Flowserve.



UI – User Interface

A large graphic display and five keys make D3 simple to operate. All information is presented clearly in text form in the display. The display itself is visible with cover installed. The menu position indicator shows you how far you are in the menu structure.

There are no LEDs, cryptic codes or other non-understandable messages on the display.

During calibration and initialization, D3 walks you thru a guide where you set actuator type and function, all you do is to select the proper setting, then simply press OK. D3 will now autocalibrate itself for optimal function.



1. **Out of Service** – Cancels setpoint and allows changes to positioner parameters.
2. **Manual** – Allows for manual selection of setpoint or jog of the valve.
3. **Unprotected** – The positioner is not write protected. All settings can be overwritten.
4. **Heading Position** – Indicates the position of shown heading within a level.
5. **Ok** – Confirms choices or changes of parameters. Performs as an "enter" key.
6. **Up and Down buttons** – To scroll menus, enter values and operate the valve in manual mode.
7. **Esc** – Escapes the menu level without any unconfirmed changes.
8. **Func** – Used to select a heading or function. Press the FUNC-key to enable editing of parameters.

PC Configurator

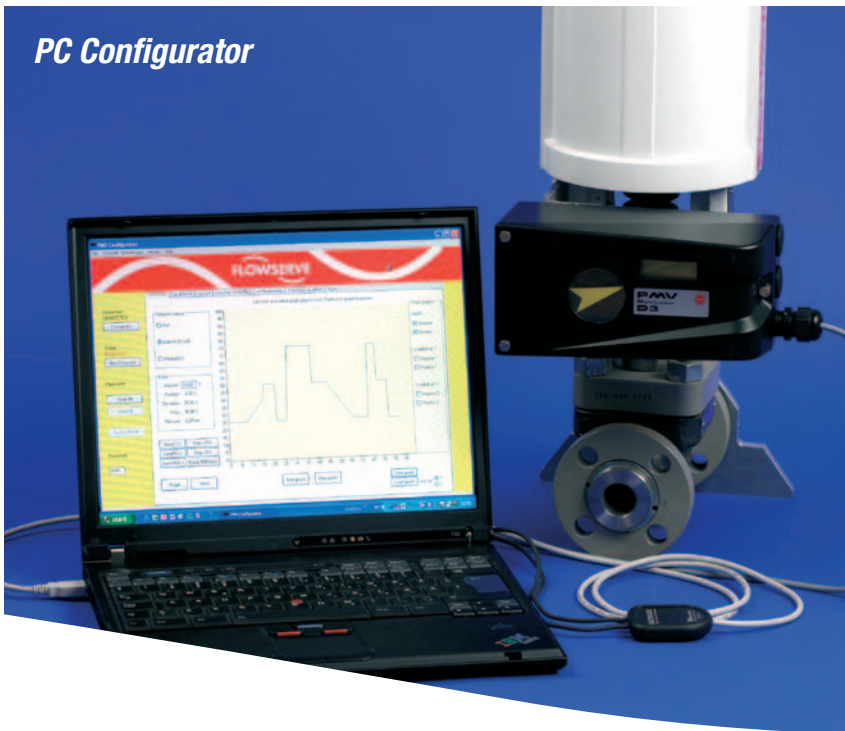

Stainless steel



PC Configurator

A PC configurator is available to connect your D3 with a PC. All you need is a HART® modem and a D3 with HART® option. This PC configurator is available free of charge.

Communication

D3 is available with HART®, Profibus PA and Foundation Fieldbus protocol for bi-directional communication, enabling remote configuration and installation from PC or a handheld communicator. Drivers are available for AMS software.

ValveSight

PMV D3 digital positioner with optional on board pressure sensors and ValveSight software offers you a powerful tool for control valve diagnostics.

A glance at the dashboard provides you with full understanding of your asset health status and possible upcoming issues.

It is based on open standards from the FDT group presents its data in a unique Graphical User Interface.



ValveSight Is Unique.

Open standards

ValveSight is based on open standards for integration and interoperability from the FDT Group, so you can rest assured that it will work with any FDT/DTM-compliant host or asset management solution.

In addition, ValveSight has also been exhaustively tested with major host providers so you can be confident that it will work for you.

Finally, ValveSight has been designed to work over a variety of protocols and has received independent certification from the relative standards associations for each.

Retrofittable

Using the Flowserve D3 digital positioner and our enormous selection of mounting brackets and hardware, the D3 with ValveSight can retrofit to almost any application you have.

Unique Graphical User Interface (GUI)

ValveSight allows users at all levels of experience or technical sophistication to be able to use the solution – no matter what kind of control valve is being used.

ValveSight uses a dashboard-like interface that does not require the user to navigate alarms to understand the health of the device. It has been specially designed to communicate complex information simply and quickly.



Powerful, but Easy to Use.

ValveSight was designed with operators in mind. The graphical user interface offers these features:

- An intuitive navigation between functions
- Easily understandable names for views and parameters
- Online self-contained help functions and manuals to speed up the maintenance and repair process
- A common look and feel between different types of control valves and systems

Thanks to ValveSight's color-coded health status, you can check the four key health parameters in one easy glance at the main dashboard: Green = normal; Yellow = warning; Red = alarm. Plus, on the yellow bar, you'll find several stages, or degrees, upon which the warning and alarm reports are based.

The screenshot shows the PACTware interface for a D3HART Actuator. The main dashboard includes a 'Health Status' table with the following data:

Health Status	Normal	Warning	Alarm
Valve:	██████████	██████████	██████████
Positioner:	██████████	██████████	██████████
Actuator:	██████████	██████████	██████████
Control:	██████████	██████████	██████████

Other dashboard elements include: Setpoint (49.3%), Position (40.5%), Deviation (0.8%), Service Status (IN SERVICE), and a temperature reading of 21.3°C.

ValveSight provides at-a-glance understanding of asset health – not alarms.

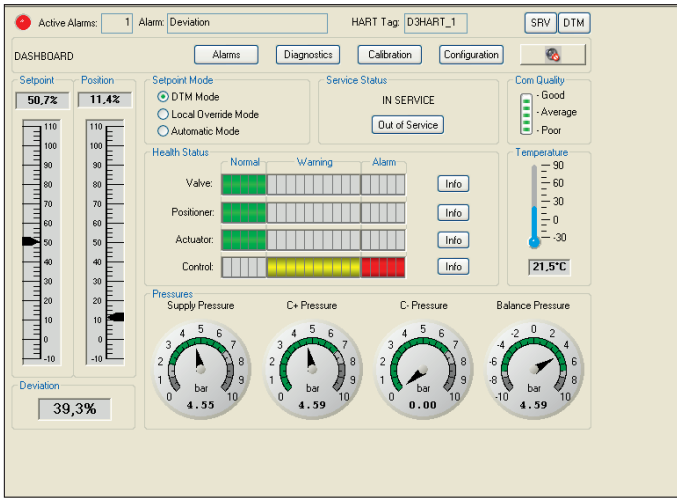

A glance at the dashboard gives all necessary information.

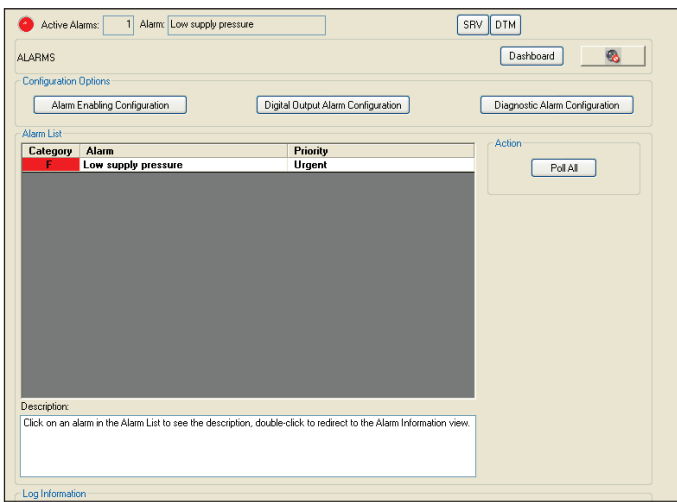

Alarms are clearly indicated.

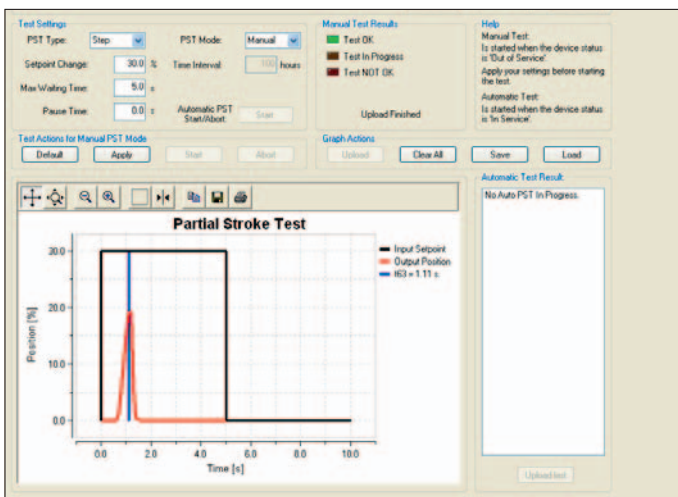

D3 and ValveSight allows "Partial Stroke Tests" to be performed and recorded.

ValveSight Is Compatible with Most Hosts.



Dimensional Drawings

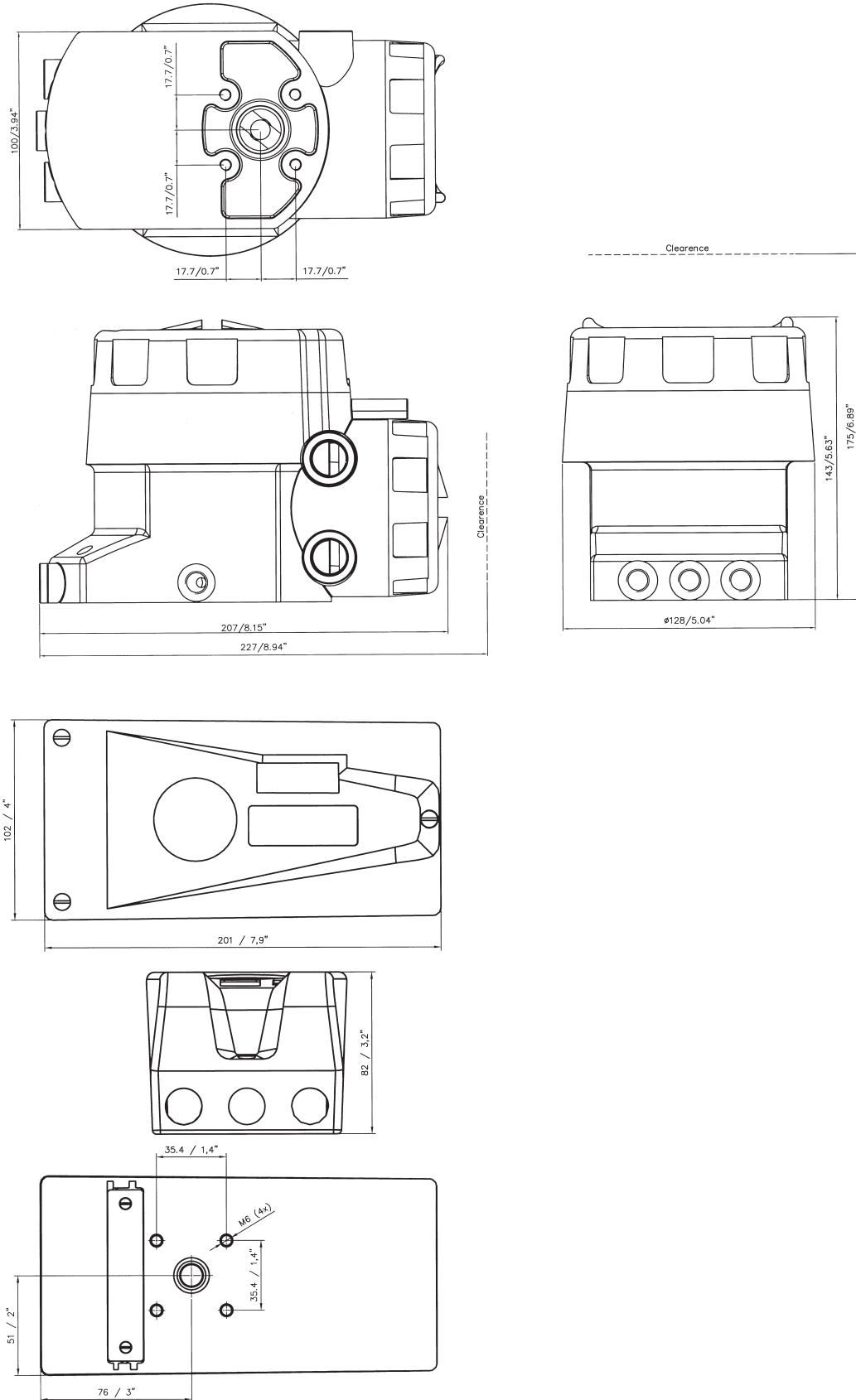



D3 Digital Positioner

Rotation angle	Min. 30° max. 100°, optional 270°
Stroke	5–130 mm (0.2" to 5.1")
Input signal	4–20 mA
Air supply	2–7 bar (30–105 Psi) Free from oil, water & moisture, filtered to min. 30 micron.
Air delivery	350 nl/min (12 scfm)
Air consumption	<0.3 nl/min (0.01 scfm)
Air connections	1/4" G or NPT
Cable entry	3 x M20 x 1.5 or 1/2" NPT
Electrical connections	Screw terminals 2.5 mm ² /AWG14
Linearity	<1%
Repeatability	<0.5%
Hysteresis	<0.4%
Dead band	0,2–10% adjustable
Display	Graphic, view area 15 x 41 mm (0.6 x 1.6")
UI	5 push buttons
Processor	16 bit, M 16C
CE directives	93/68EEC, 89/336/EEC, 92/31/EEC
EMC	EN 50 081–2, EN 50 082–2
Voltage drop	8 V (400 Ohm) non-Hart, 9,4 V (470) Ohm Hart
Vibrations	<1% up to 10g at frequency 10–500 Hz
Enclosure	IP66/ NEMA 4X
Material	Die-cast aluminium, A2/A4 fasteners
Surface treatment	Powder epoxy
Temperature range	–30°C to +80°C (–22°F to +176°F)
Weight	D3X, 1.4 kg (3 lbs) – D3E, 3 kg (6.6 lbs)
Mounting position	Any

Optional plug in module

Mechanical Switches	
Type	SPDT
Size	Sub Sub miniature
Rating	100 mA/ 30 V DC/ 42 V AC
Namur Sensors	
Type	Proximity DIN 19234 NAMUR
Load Current	1 mA ≤ I _L ≤ 3 mA
Voltage range	5–25 V DC
Hysteresis	0,2%
Temp	–20°C to +85°C (–4°F to +185°F)
Proximity Switches	
Type	SPDT
Rating	100 mA/ 30 V DC/ 42 V AC
Operating time	0,7 ms
Breakdown voltage	200 V DC
Contact resistance	0,1Ω
Mechanical/electrical life	> 50x10 ⁶ operations
4–20 mA Transmitter	
Supply	13–28 V DC
Output	4–20 mA
Resolution	0,1%
Linearity full span	+/- 0,5%
Output current limit	30 mA DC
Load impedance	800Ω @ 24 V DC
Alarmoutput	
Alarm output	Transistor Ri 1KΩ
Alarm Supply Voltage	8–28 V



D3 Series Coding

Model no

- D3X Digital positioner with display and indicator, General purpose
- D3I Digital positioner with display and indicator, Intrinsically safe ATEX
- D3E Digital positioner with display, no indicator, Explosion proof ATEX, CSA/FM
- D3F Digital positioner with display, Explosion proof ATEX, CSA/FM, Direct mount to Flowact

Connections

- G 1/4" G air, 3 pcs M20 x 1,5 electrical
- N 1/4" NPT air, 1/2" NPT electrical
- M 1/4" NPT air, M20 x 1,5 electrical

Surface treatment

- U Powder epoxy
- E Stainless Steel enclosure (only for D3E & D3F)

Function

- S Single acting
- L Single acting, Fail Freeze
- P Single acting, Fail freeze remote mounted
- M Single acting, remote mounted
- D Double acting acting
- K Double acting Fail Freeze function
- Q Double acting Fail freeze remote mounted
- R Double acting Remote mounted

Spindle

- 23 Rotary VDI/VDE 3845
- 39 D type for linear & NAF
- 09 Double D type and adaptor

Cover and Indicator (No indicator on D3E, D3F)

- PVA Black PMV, 90 deg, Arrow indicator
- PVB Black, Extended travel, 270 deg Arrow indicator

Sensors/Temperature/seals

- Z No pressure sensors, NBR -30 to +80°C
- Y On Board pressure sensors, NBR -30 to +80°C

Input signal/Protocoll

- 4 4-20 mA
- 5 HART, 4-20 mA
- P Profibus PA
- F Foundation Fieldbus (Not for D3I)

Feedback option

- X No feedback option
- T 4-20 mA transmitter only + Alarm
- S* Limit switches MEC + 4-20 mA + Alarm
- N* Limit sensors NAM + 4-20 mA + Alarm
- P* Limit switches PXY + 4-20 mA + Alarm
- 4* Slot type Namur sensor, P+F SJ2 S1N + Alarm
- 5* Slot type Namur sensor, P+F SJ2 SN + Alarm
- 6* Slot type Namur sensor, P+F SJ2N + Alarm

Accessories

- X No accessories
- M Gauge block (For D3X, D3I only, built in on D3E, D3F)

D	3				U	-							-	Z			
---	---	--	--	--	---	---	--	--	--	--	--	--	---	---	--	--	--



* Not for D3E, D3F



p/n: FCD PMENBR0001-03



Hazardous Locations 

Intrinsically safe: ATEX EEX ia IIC T4 
Explosion proof: ATEX EEX d IIB+H₂ T6 
 CSA, FM Div.1, Class 1 Group B,C,D,
 Class II Group E,F,G, Class III

Flowserve Corporation has established industry leadership in the design and manufacture of its products. When properly selected, this Flowserve product is designed to perform its intended function safely during its useful life. However, the purchaser or user of Flowserve products should be aware that Flowserve products might be used in numerous applications under a wide variety of industrial service conditions. Although Flowserve can (and often does) provide general guidelines, it cannot provide specific data and warnings for all possible applications. The purchaser/user must therefore assume the ultimate responsibility for the proper sizing and selection, installation, operation, and maintenance of Flowserve products. The purchaser/user should read and understand the Installation and Maintenance (I & M) instructions included with the product, and train its employees and contractors in the safe use of Flowserve products in connection with the specific application.

While the information and specifications contained in this literature are believed to be accurate, they are supplied for informative purposes only and should not be considered certified or as a guarantee of satisfactory results by reliance thereon. Nothing contained herein is to be construed as a warranty or guarantee, express or implied, regarding any matter with respect to this product. Because Flowserve is continually improving and upgrading its product design, the specifications, dimensions and information contained herein are subject to change without notice. Should any question arise concerning these provisions, the purchaser/user should contact Flowserve Corporation at any one of its worldwide operations or offices.

©2008 Flowserve Corporation, Irving, Texas, USA. Flowserve and PMV are registered trademarks of Flowserve Corporation.

Palmstierna International AB
 Korta Gatan 9
 SE-171 54 Solna
 SWEDEN
 Tel: +46 (0) 8 555 106 00
 Fax: +46 (0) 8 555 106 01
 E-mail: infopmv@flowserve.com

Germany
 Flowserve
 Sperberweg 16
 D-41468 Neuss
 GERMANY
 Tel: +49 (0) 2131 795 74 80
 Fax: +49 (0) 2131 795 74 99
 E-mail: pmvgermany@flowserve.com

UK
 Flowserve
 Abex Road
 Newbury, Berkshire, RG14 5EY
 UK
 Tel: +44 (0) 1635 46 999
 Fax: +44 (0) 1635 36 034
 E-mail: pmvukinfo@flowserve.com

Italy
 Flowserve Spa
 Via Prealpi, 30
 20032 Cormano (Milano)
 ITALY
 Tel: +39 (0) 2 663 251
 Fax: +39 (0) 2 615 18 63
 E-mail: infoitaly@flowserve.com

USA, Mexico
 PMV-USA
 1440 Lake Front Circle, Unit 160
 The Woodlands, TX 77380
 USA
 Tel: +1 281 292 7500
 Fax: +1 281 292 7760
 E-mail: pmvusa@flowserve.com

Canada
 Cancoppas Limited
 2595 Dunwin Drive, Unit 2
 Mississauga, Ont L5L 3N9
 CANADA
 Tel: +1 905 569 6246
 Fax: +1 905 569 6244
 E-mail: ccontrols@cancoppas.com

Asia Pacific Headquarters
 Flowserve Pte Ltd.
 No. 12 Tuas Avenue 20
 REPUBLIC OF SINGAPORE 638824
 Tel: +65 (0) 687 98900
 Fax: +65 (0) 686 24940
 E-mail: fcdasiaprocess@flowserve.com

South Africa
 Flowserve
 Unit 1, 12 Director Road
 Spartan Ext. 2
 1613 Kempton Park, Gauteng
 SOUTH AFRICA
 Tel: +27 (0) 11 397 3150
 Fax: +27 (0) 11 397 5300

The Netherlands
 Fabromatic BV
 Rechtaad 17
 4703 RC Roosendaal
 THE NETHERLANDS
 Tel: +31 (0) 30 6771946
 Fax: +27 (0) 30 6772471
 E-mail: fcbinfo@flowserve.com

China
 Flowserve
 Hanwei Building
 No. 7 Guanghua Road
 Chao Yang District
 100004 Beijing
 CHINA
 Tel: +86 (10) 6561 1900
 Fax: +86 (10) 6561 1899

www.pmv.nu