

User's Guide

Laser Diode Mount LDM-4980





TABLE OF CONTENTS



Table of Contents i

List of Figures iii

List of Tables v

Safety and Warranty Information vii

 Safety Information and the Manualvii

 General Safety Considerationsvii

Safety Symbols viii

 Safety Marking Symbols viii

Warranty ix

 Comments, Suggestions, and Problems x

Chapter 1 Introduction

Product Overview 1

Specifications 4

Chapter 2 Operation

Electrical Connections 7

 LDM-4980 General Wiring Instructions 7

 LDM-4986 Wiring 11

 LDM-4983 and LDM-4989 Hotplate and Laser Diode Case
 Potential Wiring 13

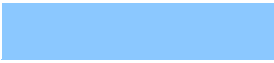

TABLE OF CONTENTS

Electrical Precautions	14
ILX Lightwave Current Source Interlock Feature	14
ILX Lightwave Model CC305S Interconnect Cable	14
Laser Diode Mounting	15
LDM-4982, DIL Laser Mounting	15
LDM-4982M Mini-DIL Laser Mounting	16
LDM-4984, LDM-4984T, LDM-4989, and LDM-4989T Two-Sided Butterfly Laser Mounting	17
LDM-4984RF and LDM-4984TRF Mounting	18
LDM-4983 and LDM-4983T Single-Side Butterfly Mounting	20
LDM-4986, Connectorized Laser Mounting	21
Bias-T Option	21
Case Temperature Control Option	21
Current Sources and Current Measurements	23
Disassembly	23

Chapter 3 Maintenance

Chapter 4 Safety



LIST OF FIGURES



Figure 2.1	Bottom View of a Typical LDM-4980 Mount	8
Figure 2.2	Mount Bottom Covers	9
Figure 2.3	Fujitsu “LK” Package Laser Diode	12
Figure 2.4	LDM-4892M Pin 1 Location	16
Figure 2.5	Top View of the LDM-4984RF Mount	19

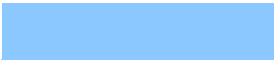

LIST OF FIGURES



LIST OF TABLES



Table 1.1 ILX Lightwave Mount Types and Packages 2

Table 2.1 Laser Diode Pin Configuration with Internal TEC 9

Table 2.2 Butterfly Package Wiring Configuration 10

Table 2.3 LDM-4986 Connector Configuration and Wire Colors 12

Table 2.4 Connectorized Laser Diode Wiring Configuration 13

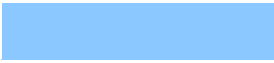

LIST OF TABLES

SAFETY AND WARRANTY INFORMATION

The Safety and Warranty Information section provides details about cautionary symbols used in the manual, safety markings used on the instrument, and information about the Warranty including Customer Service contact information.

Safety Information and the Manual

Throughout this manual, you will see the words *Caution* and *Warning* indicating potentially dangerous or hazardous situations which, if not avoided, could result in death, serious or minor injury, or damage to the product. Specifically:

CAUTION

Caution indicates a potentially hazardous situation which can result in minor or moderate injury or damage to the product or equipment.

WARNING

Warning indicates a potentially dangerous situation which can result in serious injury or death.

WARNING

Visible and/or invisible laser radiation. Avoid direct exposure to the beam.

General Safety Considerations

If any of the following conditions exist, or are even suspected, do not use the instrument until safe operation can be verified by trained service personnel:

- Visible damage
- Severe transport stress
- Prolonged storage under adverse conditions
- Failure to perform intended measurements or functions

If necessary, return the instrument to ILX Lightwave, or authorized local ILX Lightwave distributor, for service or repair to ensure that safety features are maintained (please see the contact information on page x).

All instruments returned to ILX Lightwave are required to have a Return Authorization Number assigned by an official representative of ILX Lightwave Corporation. See Returning an Instrument on page ix for more information.

SAFETY SYMBOLS









This section describes the safety symbols and classifications.

Technical specifications including electrical ratings and weight are included within the manual. See the Table of Contents to locate the specifications and other product information. The following classifications are standard across all ILX Lightwave products:

- Indoor use only
- Ordinary Protection: This product is NOT protected against the harmful ingress of moisture.
- Class I Equipment (grounded type)
- Mains supply voltage fluctuations are not to exceed $\pm 10\%$ of the nominal supply voltage.
- Pollution Degree II
- Installation (overvoltage) Category II for transient overvoltages
- Maximum Relative Humidity: $< 80\%$ RH, non-condensing
- Operating temperature range of $0\text{ }^{\circ}\text{C}$ to $40\text{ }^{\circ}\text{C}$
- Storage and transportation temperature of $-40\text{ }^{\circ}\text{C}$ to $70\text{ }^{\circ}\text{C}$
- Maximum altitude: 3000 m (9843 ft)
- This equipment is suitable for continuous operation.

Safety Marking Symbols

This section provides a description of the safety marking symbols that appear on the instrument. These symbols provide information about potentially dangerous situations which can result in death, injury, or damage to the instrument and other components.

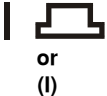
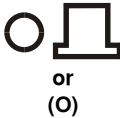
 Caution, refer to manual	 Earth ground Terminal	 Alternating current	 Visible and/or invisible laser radiation
 Caution, risk of electric shock	 Protective Conductor Terminal	 Caution, hot surface	 Frame or chassis Terminal
 On: In position of a bistable push control. The slash (I) only denotes that mains are on.	 Off: Out position of a bistable push control. The circle (O) only denotes that mains are off.		

WARRANTY

ILX LIGHTWAVE CORPORATION warrants this instrument to be free from defects in material and workmanship for a period of one year from date of shipment. During the warranty period, ILX will repair or replace the unit, at our option, without charge.

Limitations

This warranty does not apply to fuses, lamps, defects caused by abuse, modifications, or to use of the product for which it was not intended.

This warranty is in lieu of all other warranties, expressed or implied, including any implied warranty of merchantability or fitness for any particular purpose. ILX Lightwave Corporation shall not be liable for any incidental, special, or consequential damages.

If a problem occurs, please contact ILX Lightwave Corporation with the instrument's serial number, and thoroughly describe the nature of the problem.

Returning an Instrument

If an instrument is to be shipped to ILX Lightwave for repair or service, be sure to:

- 1 Obtain a Return Authorization number (RA) from ILX Customer Service.
- 2 Attach a tag to the instrument identifying the owner and indicating the required service or repair. Include the instrument serial number from the rear panel of the instrument.
- 3 Attach the anti-static protective caps that were shipped with the instrument and place the instrument in a protective anti-static bag.
- 4 Place the instrument in the original packing container with at least 3 inches (7.5 cm) of compressible packaging material. **Shipping damage is not covered by this warranty.**
- 5 Secure the packing box with fiber reinforced strapping tape or metal bands.
- 6 Send the instrument, transportation pre-paid, to ILX Lightwave. Clearly write the return authorization number on the outside of the box and on the shipping paperwork. ILX Lightwave recommends you insure the shipment.

If the original shipping container is not available, place your instrument in a container with at least 3 inches (7.5 cm) of compressible packaging material on all sides.

Repairs are made and the instrument returned transportation pre-paid. Repairs are warranted for the remainder of the original warranty or for 90 days, whichever is greater.

Claims for Shipping Damage

When you receive the instrument, inspect it immediately for any damage or shortages on the packing list. If the instrument is damaged, file a claim with the carrier. The factory will supply you with a quotation for estimated costs of repair. You must negotiate and settle with the carrier for the amount of damage.

Comments, Suggestions, and Problems

To ensure that you get the most out of your ILX Lightwave product, we ask that you direct any product operation or service related questions or comments to ILX Lightwave Customer Support. You may contact us in whatever way is most convenient:

Phone (800) 459-9459 or (406) 586-1244

Fax (406) 586-9405

Email. support@ilxlightwave.com

Or mail to:

ILX Lightwave
31950 Frontage Road
Bozeman, Montana, U.S.A 59715
www.newport.com/ilxlightwave

When you contact us, please have the following information:

Model Number: _____

Serial Number: _____

End-user Name: _____

Company: _____

Phone: _____

Fax: _____

Description or sketch of what is connected to the ILX Lightwave instrument:

Description of the problem:

If ILX Lightwave determines that a return to the factory is necessary, you are issued a Return Materials Authorization (RMA) number. Please mark this number on the outside of the shipping box.

You or your shipping service are responsible for any shipping damage when returning the instrument to ILX Lightwave; ILX recommends you insure the shipment. If the original shipping container is not available, place your instrument in a container with at least 3 inches (7.5cm) of compressible packaging material on all sides.

We look forward to serving you even better in the future!

The LDM-4980 Series offers a high-value laser diode fixturing solution, and are ideal for use with ILX Lightwave laser diode control instrumentation.

Model Number	Package Type	Bias-T Option	Modulation Bandwidth	RF Input Impedance	Hot Plate Connection
LDM-4982	DIL	Call ILX for details	10 MHz - 800 MHz ¹	50Ω ¹	Floating
LDM-4982M ⁵	Mini-DIL	--	--	--	Floating
LDM-4983	13-pin RF Butterfly ² 7-pin RF Butterfly ³	--	See Note 2	--	User Configurable
LDM-4984	14-pin Butterfly	LDM-4984-BTB LDM-4984T-BTB	10 MHz - 800 MHz ¹	50Ω ¹	Floating
LDM-4984RF ⁴	14-pin Internal Bias-T Modulated	--	10 MHz - 2.5 GHz	50Ω / 25Ω	Floating
LDM-4986 ⁵	Connectorized	--	--	--	Floating
LDM-4989	26-pin Butterfly 20-pin Butterfly	--	--	--	User Configurable

Table 1.1 ILX Lightwave Mount Types and Packages

1. Modulation bandwidth with Bias-T option.
2. Typically 10Gbit/s laser application. All pins are on one side of laser package and coaxial RF connector is on other side of laser package.
3. LDM-4983 13-pin RF mount can be used with 7-pin butterfly laser package by using every other pin of the 13-pin ZIF socket and wiring the mount accordingly.
4. Typically 2.5GHz laser application. Mount connects RF launch block to pin-12 for internal Bias-T. LDM-4984RF mount designed for lasers with 25 Ω input impedance to internal Bias-T modulation. The RF input on the mount is a 50 Ω SMA connector.
5. Case temperature control is standard on the LDM-4982M and LDM-4986 mount.

The LDM-4980 mounts allow direct interfacing to all of ILX Lightwave's current sources and temperature controllers through standard ILX cables (except LDM-4989). This feature gives you the flexibility to select the proper current source or temperature controller for your particular application.

Within the laser mount, screw-lead configuration headers allow you to configure the wiring of the mount to accept variations of laser package pin-outs. The LDM-4982 and LDM-4984 mounts are available with a Bias-T option to facilitate high-speed laser current modulation. The Bias-T option accepts a 50 Ω impedance-matched modulation input through a standard SMA RF connector.

Wiring is provided for controlling the laser's internal thermoelectric modules. In addition, the case temperature control option is available. This option allows for simultaneous and independent control of both laser die temperature and package temperature for controlled-environment testing or where extreme temperature stability is required.

The LDM-4980 consists of a housing, laser heat sink/PCB assembly, and a bottom cover. The housing includes a grounding receptacle for a wrist strap, as well as a grounded laser cover to improve thermal stability and help shield the laser from radiated noise and transients.

Specifications

LDM Model Number	Package Type
LDM-4982	DIL
LDM-4982M	Mini-DIL
LDM-4983 / LDM-4983T	13-pin, RF; 7-pin RF
LDM-4984 / LDM-4984T / LDM-4984-BTB / LDM-4984T-BTB	14-pin Butterfly
LDM-4984RF / LDM-4984-TRF	Internal Bias-T Modulated 14-pin Butterfly
LDM-4986	Connectorized
LDM-4989 / LDM-4989T	26-pin Butterfly; 20-pin Butterfly
Input Connectors	
9-pin D-sub Connectors	1. Laser diode current (female) 2. Internal laser temperature control (male) 3. Laser package temperature control (male)
Operating Current	
Maximum Laser Diode Current	2.0 A
Laser Package Temperature Control Option ¹	
Temperature Control Range ^{2,3}	-5°C to 85°C
Sensor Type	10kΩ Thermistor
TE Module Ratings	$Q_{\max} = 14 \text{ W}$, $\Delta T_{\max} = 70^\circ\text{C}$ $I_{\max} = 6.0 \text{ A}$, $V_{\max} = 4.2 \text{ V}$
Bias-T Option RF Input Specifications ⁴	
Modulation Bandwidth	10MHz to 800MHz
Input Impedance	50Ω (LDM-4982 / LFM-4984) 50Ω / 25Ω (LDM-4984RF / LFM-4984TRF);
Connector	SMA
General	
Size (HxWxD)	1.25" x 4.0" x 5.5" (31.8mm x 102mm x 140mm)
Weight	1.4 pounds (0.64 kg)

- Optional except on LDM-4982M and LDM-4986. See ordering information. Laser package TE option adds approximately 1.5" to width and 0.3" to height of mount. Baseplate may be affixed to optical table for additional heat sink. (Screws are included.)
- Typical case temperature control range. Actual temperature range depends on ambient temperature, environmental conditions, and heat generated in laser module.
- Colder temperatures must be in non-condensing environment.
- Optional for LDM-4982 and LDM-4984; standard for LDM-4984 and LDM-4984TRF. Bias-T options allow user configuration of laser pins except for LD cathode and anode. (See table). Bandwidth measured at laser pin. Actual optical modulation BW is dependent upon laser used.
- For the LDM-4982M, minimum temperature at 1.5 Watts.

Bias-T and 2.5Gbits/s Pin Configuration Guide

Circuit Type	Mount Integrated Bias-T	2.5Gbits/s Internally Modulated Lasers
Package Type	Butterfly	Butterfly-RF
Mount Option	LDM-4984-BTB LDM-4984T-BTB	LDM-4984RF LDM-4984TRF
PIN 1	*	*
PIN 2	*	*
PIN 3	*	*
PIN 4	*	*
PIN 5	*	*
PIN 6	*	*
PIN 7	*	*
PIN 8	*	Laser Anode/Case
PIN 9	*	Laser Anode/Case
PIN 10	Laser Anode/Case	Laser Anode/Case
PIN 11	Laser Cathode	Laser Anode/Case
PIN 12	*	Modulation (AC in)
PIN 13	*	Laser Anode/Case
PIN 14	*	Laser Anode/Case

* User configurable pin assignment. All pins are configurable on other mount versions.

Our goal is to make the best laser diode instrumentation available anywhere. To achieve this, we need your ideas and comments on ways we can improve our products. We invite you to contact us at any time with your suggestions.



This chapter describes the electrical configuration and mounting of laser diodes. Generic procedures that apply to all mounts in the series are referred to as LDM-4980. Procedures that are specific to a mount are prefaced with the particular model number (LDM-4982, LDM-4984, etc.)

Electrical Connections

CAUTION

Laser diodes are extremely susceptible to damage caused by electrostatic discharge and surge currents. To avoid early failure or damage to the device, workers and work benches must be grounded at all times when handling or working with laser diodes.

For more information on laser diode protection strategies, refer to Application Note #3, "Protecting Your Laser Diode." This document is available from your ILX Lightwave representative, or you can find it on our website www.ilxlightwave.com.

LDM-4980 General Wiring Instructions

The LDM-4980 Series Mounts are equipped with configurable pin headers which allow the mount to be configured for any appropriate laser diode pin-out. These headers are accessed by unscrewing the rubber feet on the bottom of the mount and removing the bottom cover or by removing the bottom plate if the mount is configured with the laser case temperature control option.

A drawing of the inside of a typical LDM-4980 mount is shown in Figure 2.1. Holding the mount upside down, notice the configuration headers on the left and right of the printed circuit board and pedestal. The pin headers are connected to the laser socket(s) via the printed circuit board, the numbers next to the headers designate the laser pin number. There are up to three 9-pin D connectors in the mount for laser current control, laser internal temperature control, and laser

package temperature control. The pair of 9-pin connectors are the laser current control and laser internal temperature control. The one 9-pin connector opposite the two together, is for laser package temperature control only if the mount is configured with the case temperature control option. Color coded wires are soldered to the 9-pin D-connectors and un-terminated at the other end. These connectors mate with the current and temperature control cables from ILX Lightwave laser current sources and temperature controllers, therefore, the pin designations are pre-determined by the instrumentation. These pin-outs with their corresponding wire color are shown on the inside of the bottom cover of the laser diode mount.

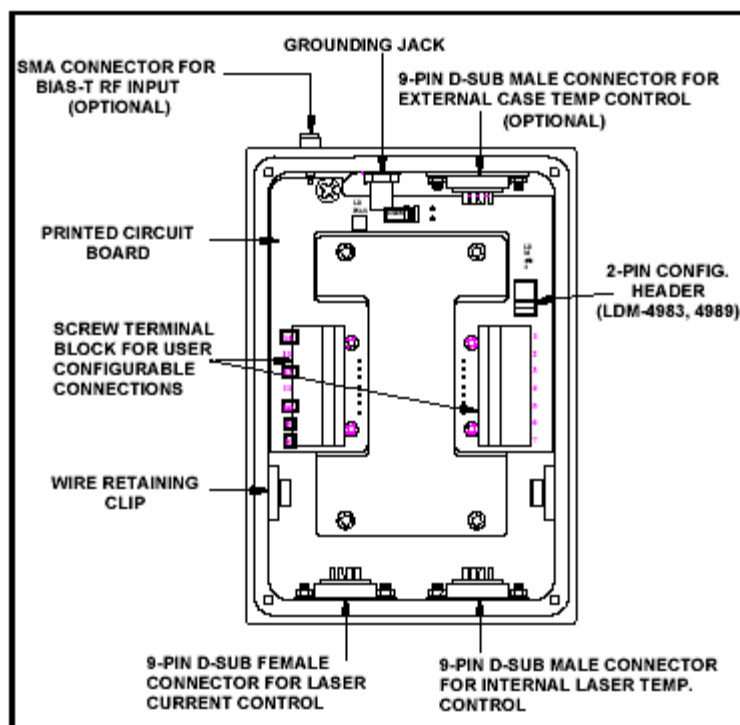

Figure 2.1 Bottom View of a Typical LDM-4980 Mount (Bottom Cover Removed)

The mount is configured for your laser diode by connecting the color coded wires from the 9-pin connector to the corresponding pin on the configurable header. Insert the wire into the header and tighten the clamping screw. The connector pin designations and wire color codes for all LDM-4980 Series Laser Diode Mounts except the LDM-4986 are shown in Figure 2.2.

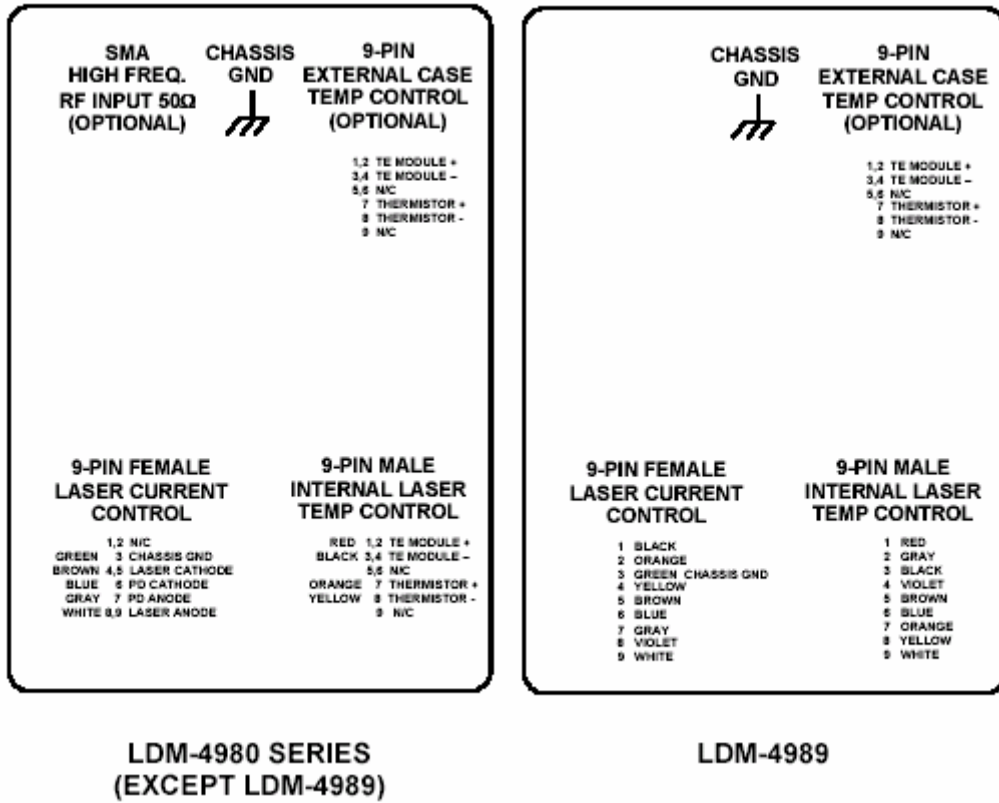

Figure 2.2 Mount Bottom Covers

An example for a laser diode with internal TEC is given below:

Pin #	Description	Pin #	Description
1	Peltier Cooler (+)	8	Not Connected
2	Thermistor	9	Not Connected
3	Monitor Anode (-)	10	Laser Anode (+)
4	Monitor Cathode (+)	11	Laser Cathode (-)
5	Thermistor	12	Not Connected
6	Not Connected	13	Case Ground
7	Not Connected	14	Peltier Cooler (-)

Table 2.1 Laser Diode Pin Configuration with Internal TEC

Note: Information Courtesy of Bookham Technology

To configure the mount for this particular laser diode, follow the instructions below:

- 1 Starting with pin 1, Peltier cooler (+), you would connect the red wire from the 9-pin male Internal Laser Temp Control connector to pin 1 of the configurable header.
- 2 Next, pin 2 of the laser is the thermistor, connect the orange wire from the 9-pin male Internal Laser Temp Control connector to pin 2 of the configurable header.
- 3 For pin 3, monitor anode, connect the gray wire from the 9-pin Female Laser Current Control connector to pin 3 of the configurable header.
- 4 For pin 4, monitor cathode, connect the blue wire from the 9-pin Female Laser Current Control connector to pin 4 of the configurable header.
- 5 For pin 5, thermistor, connect the yellow wire from the 9-pin male Internal Laser Temp Control connector to pin 5 of the configurable header.
- 6 There are no connections for pin 6, 7, 8 and 9.
- 7 For pin 10, laser anode, connect the white wire from the 9-pin Female Laser Current Control connector to pin 10 of the configurable header.
- 8 For pin 11, laser cathode, connect the brown wire from the 9-pin Female Laser Current Control connector to pin 11 of the configurable header.
- 9 There are no connections for pin 12 and 13.
- 10 To finish the wiring, for pin 14, peltier cooler (-), connect the black wire from the 9-pin male Internal Laser Temp Control connector to pin 14 of the configurable header.

The configuration information with connector designation with corresponding wire color is summarized in Table 2.2.

Pin	Designation	Wire Color	Mount Connector	Pin	Designation	Wire Color	Mount Connector
1	TE Cooler (+)	Red	Internal laser temp control	8	NC	-----	
2	Thermistor	Orange	Internal laser temp control	9	NC	-----	
3	Monitor Anode (-)	Gray	Laser current control	10	Laser Anode (+)	White	Laser current control
4	Monitor Cathode (+)	Blue	Laser current control	11	Laser Cathode (-)	Brown	Laser current control
5	Thermistor	Yellow	Internal laser temp control	12	NC	-----	
6	NC	-----		13	NC	-----	
7	NC	-----		14	TE Cooler (-)	Black	Internal laser temp control

Table 2.2 Butterfly Package Wiring Configuration

The mount is now configured for this laser module. It is always a good idea to double check your work before powering up the laser diode to make sure the connections are correct.

Please note that some connections on the laser package may have multiple pins. These pins are usually a common ground and one or two other functions. Do not be concerned if one or more of these common pins are left unconnected. Simply verify that each laser pin is correctly connected to the corresponding 9-pin connector pin through the configurable header. Once all appropriate connections have been made and verified, attach the bottom cover.

LDM-4986 Wiring

The LDM-4986 Connectorized Laser Diode Mount is equipped with a 4-position configurable pin header which allows the mount to be configured for any three or four pin connectorized laser diode. These headers are accessed by removing the bottom plate of the mount.

Holding the mount upside down, notice the configuration header on the left side of the printed circuit board and pedestal. The pin header is connected to the 4-pin laser socket via the printed circuit board, the numbers next to the headers designate the laser pin number. There are two 9-pin D connectors for the laser current control and laser case temperature control. The 9-pin male connector is for case temperature control, the 9-pin female connector is for laser current control. Color coded wires are soldered to the 9-pin D-connectors and un-terminated at the other end. These connectors mate with the current and temperature control cables from ILX Lightwave laser current sources and temperature controllers, therefore, the pin designations are pre-determined by the instrumentation. These pin-outs with their corresponding wire color are shown on the inside of the bottom cover of the laser diode mount and in Table 2.3.

The mount is configured for your laser diode by connecting the color coded wires from the 9-pin connector to the corresponding pin on the configurable header. Insert the wire into the header and tighten the clamping screw.

Table 2.3 LDM-4986 Connector Configuration and Wire Colors

9 Pin Female Laser Current Control		
Wire Color	Pin	Description
	1,2	N/C
Green	3	Chassis Ground
Brown	4,5	Laser Cathode
Blue	6	PD Cathode
Gray	7	PD Anode
White	8,9	Laser Anode

An example for a connectorized laser is given in Figure 2.3:

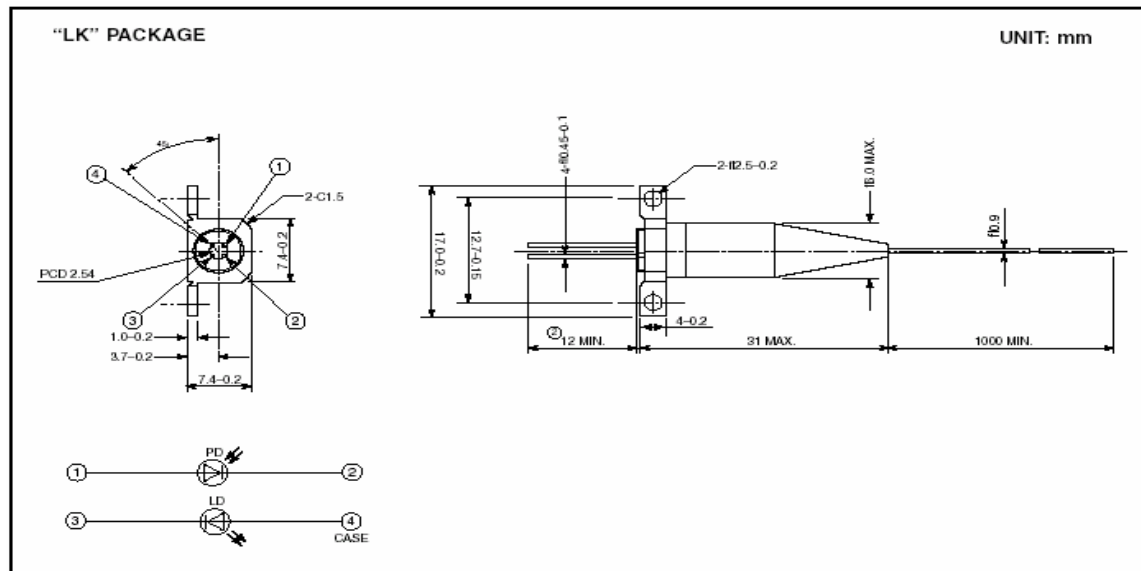

Figure 2.3 Fujitsu “LK” Package Laser Diode

To configure the mount for this particular laser diode, follow the instructions below

- 1 Starting with pin 1, PD monitor cathode (-), you would connect the blue wire from the 9-pin female Laser Current Control connector to pin 1 of the configurable header.
- 2 Next, pin 2 of the laser is the PD monitor anode (+), connect the gray wire from the 9-pin female Laser Current Control connector to pin 2 of the configurable header.
- 3 For pin 3, laser anode, connect the white wire from the 9-pin Female Laser Current Control connector to pin 3 of the configurable header.
- 4 For pin 4, laser cathode, connect the brown wire from the 9-pin Female Laser Current Control connector to pin 4 of the configurable header.

The configuration information with connector designation with corresponding wire color is summarized in Table 2.4.

Pin	Designation	Wire Color	Mount Connector
1	Monitor Cathode (-)	Blue	Laser current control
2	Monitor Anode	Gray	Laser current control
3	Laser Anode (+)	White	Laser current control
4	Laser Cathode (-)	Brown	Laser current control

Table 2.4 Connectorized Laser Diode Wiring Configuration

The mount is configured for this laser module. It is always a good idea to double check your work before powering up the laser diode to make sure the connections are correct. Once all appropriate connections have been made and verified, attach the bottom cover.

LDM-4983 and LDM-4989 Hotplate and Laser Diode Case Potential Wiring

CAUTION

Many laser diodes have one or more pins electrically connected to the case. Do not wire the hotplate if the laser diode case is electrically connected to a pin. Doing so may cause damage or destruction of the laser diode and may potentially damage the test equipment connected to the mount.

On models LDM-4983 and LDM-4989, the laser diode case is electrically connected to the hotplate, and the hotplate is electrically isolated from the mount body. On these models, the hotplate, and hence, the laser diode case, is electrically connected to a two-pin configuration header (see Figure 2.1). This socket can be left floating or wired to electrically configure the laser case as the application requires, 1) grounded, or 2) at a user-specified potential.

On the LDM-4983 and LDM-4989 the potential of the hotplate and laser diode case can be configured by following steps 1-3 below:

- 1 Remove the bottom plate from the mount to access the two-pin configuration header.
- 2 Connect a wire from a D-sub connector to the open socket on the two-pin configuration header as the application requires. The wire may be grounded or connected to a user-specified potential. Refer to the caution statement above regarding laser packages where the laser diode case is electrically connected to a pin.
- 3 Re-attach the bottom cover.

Electrical Precautions

CAUTION

It is extremely important that you verify that the wiring of the configurable headers is correct for your laser type (pinout). Incorrect wiring of these headers may result in destruction or damage of the laser device.

The LDM-4980 mount is compatible with all current sources and temperature controllers manufactured by ILX Lightwave. If you are using any other laser driver, use extreme caution when connecting cables from the mount to the driver. Check the laser driver/temperature controller pin-out for compatibility with this mount before connecting the instruments.

When using the LDM-4989 mount, verify all wiring is correct before connecting the current source and temperature control cables. The LDM-4989 may have multiple wires connected to the same potential; ensure all electrically active wires are connected in pin configuration headers to avoid short circuits from the live wires.

ILX Lightwave Current Source Interlock Feature

In compliance with Federal CDRH requirements, ILX Lightwave current sources employ a system interlock feature. The interlock connections are available at pins 1 and 2 of the current source output connector. The interlock pins must be shorted together before current can flow from the source. ILX Lightwave's model CC-305S interconnect cable contains a jumper between these two pins; therefore, no special action is necessary if this cable is used. If a user-supplied cable is used with an ILX Lightwave current source, the interlock pins will have to be shorted in the cable.

Refer to the laser diode drive instrument manual for more information on the interlock feature.

ILX Lightwave Model CC305S Interconnect Cable

Properly shielded current source and temperature controller signals are necessary to ensure proper low-noise performance and immunity to radiated transients. Based on findings from laboratory testing at ILX Lightwave, we have created a unique twisted-pair cable with braided outer shield. The Model CC-305S cable has been designed to provide the best possible rejection of most noise signals. Although every situation is different, we feel that this cable provides the best shielding over the widest range of operational conditions.

Laser Diode Mounting

CAUTION

Laser diodes are extremely susceptible to damage caused by electrostatic discharge and surge currents. To avoid early failure or damage to the device, workers and work benches must be grounded at all times when handling or working with laser diodes. Refer to Application Notes #3, "Protecting Your Laser Diode," for more information.

The LDM-4980 mount is equipped with a grounding jack at the side of the unit, which is electrically connected to the mount chassis. We strongly recommend that you electrically ground yourself with a wrist strap so that you are assured of being at the same potential as the mount chassis.

Prior to inserting the laser, connect the ILX Lightwave current source to the mount. At this time, also connect the temperature controller if the laser is equipped with an internal temperature control module. Finally, connect the temperature controller for the external case temperature control if the case temperature control option was ordered.

When the mount electrical connections and laser driver are correctly configured, the laser cathode and anode connections are shorted through the ILX Lightwave current source when the current drive is switched off. This prevents damage to the laser from electrostatic discharge and supports other laser safety features of all ILX Lightwave laser diode drivers.

LDM-4982, DIL Laser Mounting

The LDM-4982 is designed to allow quick and easy insertion of DIL-packaged lasers via a 14-pin zero-insertion-force (ZIF) socket. Simple lever actuation provides reliable electrical connections to all laser pins. Once installed in the socket, the rear flange of the laser package is friction-clamped to the mount heat sink. (Note that the clamp fingers may be removed and the laser screwed directly to the heat sink, if desired.)

To mount a DIL laser diode, follow steps 1-4.

- 1 Open the socket by lifting the lever into the vertical position.
- 2 While pressing on the rear of the laser, carefully slide the rear flange down between the heat sink and the clamp fingers. To maximize the clamping force between the laser flange and the heat sink, you may fasten the laser directly to the heat sink. Remove the clamp fingers by removing two screws with a 1/16" hex key wrench. Fasten the laser flange to the heat sink using the same screws that held the clamp fingers.

For maximum thermal performance, it is recommended that a thermal compound be used at the interface between the heat sink and the rear flange. This will maximize the heat transfer from the package and reduce the temperature gradient produced by a metal-to-metal interface. A thermal pad material may also be used, but this is not recommended.

- because the abrasive action of installing the laser will require frequent pad replacement.
- 3 When all laser pins are fully inserted into the socket, move the lever into the horizontal position.
 - 4 After installing your laser, replace the grounded laser cover. The cover improves thermal stability and helps provide shielding from radiated noise and transients in your laboratory. Make sure that the cover is pushed completely down over the grounding pin.

LDM-4982M Mini-DIL Laser Mounting

The LDM-4982M is designed to allow quick and easy insertion of mini-DIL laser modules via a 14-pin zero-insertion-force socket. Only 8 of the 14 pins will be used for Mini-DIL packaged diodes. Simple lever actuation provides reliable electrical connections to all laser pins. Once installed in the socket, the laser module is held against the mount with a spring loaded clamp.

To load a mini-DIL laser diode, follow steps 1 - 4.

- 1 Open the socket by lifting the lever into the vertical position.
- 2 While pressing on the laser diode, carefully slide the laser down into the socket with the pins of the laser aligned with the first eight (two rows of four) pins closest to the clamp, see Figure 2.4. The fiber pigtail should be opposite to the spring loaded clamp.
- 3 When all laser pins are fully inserted into the socket, move the lever into the horizontal position.
- 4 After installing the laser diode, replace the grounded laser cover. The cover improves thermal stability and helps provide shielding from radiated noise and transients. Make sure the cover is pushed completely down over the grounding pin.

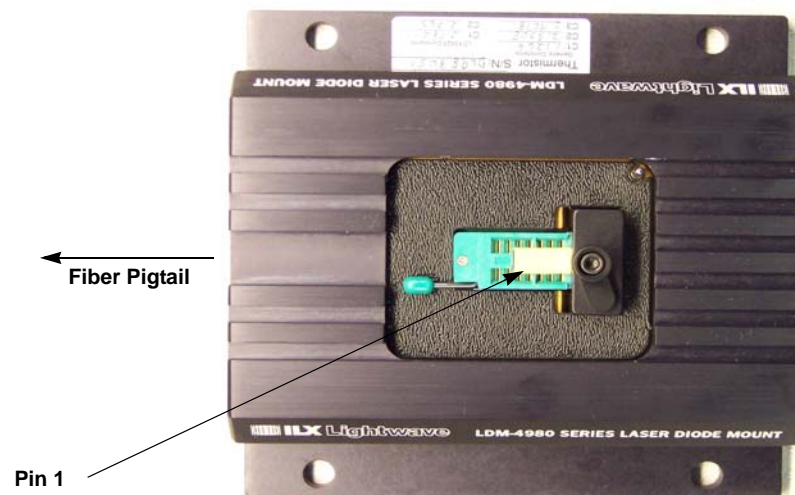

Figure 2.4 LDM-4982M Pin 1 Location

LDM-4984, LDM-4984T, LDM-4989, and LDM-4989T Two-Sided Butterfly Laser Mounting

The LDM-4984 and LDM-4989 allow simple case clamping and electrical connection through the use of flat ZIF sockets. Once installed in the socket and clamped, the entire laser package bottom surface is clamped to a heat sink.

To mount a butterfly-packaged laser diode, follow steps 1-7.

- 1 Open both sockets by releasing the lock-latch, and lifting the contact arm.
- 2 Position both laser hold-down clamps away from the thermal pad area on the heat sink. To move the clamps, simply lift up against spring pressure and rotate.

On Model LDM-4989, as an alternative to the hold-down clamps, four hold down screws can be used to secure the laser package.

- 3 Holding the laser package by the corners, carefully lower the laser onto the heat sink, while aligning the laser leads with the contacts of each socket. Note that on one side of the mount there is a "valley" in the chassis. The laser is to be mounted so that the fiber is over this "valley." Use caution when installing the laser to ensure it is not inserted backwards.

Note: The LDM-4984 Butterfly socket has been designed for laser lead heights of 6mm, nominally. Socket spacers (rectangular black plastic with oval slot) have been provided with your mount to adjust the height of the sockets (laser lead height) to approximately 7.2mm. If the lead height on your laser diode is greater than 6.6mm, it is recommended to use the spacers. Simply remove the sockets with a 5/64" size hex key wrench, place the spacers flat at the base of the sockets, and replace and secure the sockets. Be careful to ensure that the sockets and spacers are seated flat on the mounting surface.

If the lead height of your laser diode is less than 6mm, you may wish to insert one or more thermal pads under the base of your laser diode. (One extra thermal pad is provided with the LDM-4984 mount). Each pad is approximately 0.15mm thick.

- 4 It is possible to misalign the leads in the ZIF sockets when installing the laser. Verify that all leads are properly positioned in the socket before continuing. Failure to properly align the leads in the sockets may result in laser device damage.
- 5 Fix the laser package in the mount by rotating both clamps onto the package flange and release. If four hold down screws are used instead of the clamps (LDM-4989), hand tighten the screws with the provided hex key wrench.
- 6 Carefully lower the contact arm on each ZIF socket and rotate the lock-latch up over the arm until it snaps in place. Verify other connections; the laser is ready for operation.
- 7 After installing your laser, replace the grounded laser cover. The cover improves thermal stability and helps provide shielding from radiated noise and transients in your laboratory. Make sure that the cover is pushed completely down over the grounding pin.

LDM-4984RF and LDM-4984TRF Mounting

The LDM-4984RF and LDM-4984TRF mounts are equipped with a grounding jack at the side of the unit which is electrically connected to the mount chassis. We strongly recommend that you electrically ground yourself with a wrist strap so that you are assured of having your body at the same potential as the mount chassis.

Prior to inserting the laser, connect the ILX Lightwave current source to the mount. At this time, also connect the temperature controller if the laser is equipped with an internal temperature control module. Finally, connect the temperature controller for the external case temperature control if the TE550 option was ordered.

When the mount electrical connections and laser driver are correctly configured, the laser cathode and anode connections are shorted through the current source when the current source is switched off. This prevents damage to the laser from electrostatic discharge, and supports other laser safety features of all ILX Lightwave laser diode drivers.

- 1 Remove the four laser mounting screws at the heat sink corners using the supplied hex key wrench.
- 2 Open both ZIF sockets by releasing the lock-latch, and lifting the contact arm.
- 3 Holding the laser package by the corners, carefully lower the laser onto the heatsink, while aligning the laser leads with the appropriate contacts.

Note: Ensure that the laser package is not installed backwards. See Figure 2.3.

- 4 Make sure that the laser package is pressed against the RF launch block and the leads are properly positioned in the socket and on the RF board. If the laser is not pressed firmly against the RF launch block, or the laser will not fit properly, the RF launch block may be adjusted as follows:
 - 4a Slightly loosen the two hex-head RF launch block hold-down screws with a hex key wrench.
 - 4b Press the RF launch block firmly against the laser and verify the pins align properly to the contact strip on the launch block top surface.
 - 4c Gently tighten the two hold-down screws.
- 5 To ensure optimum performance verify that the laser RF leads contact the RF launch block for the entire lead length.
- 6 Re-install the four hold-down screws at the laser package corners and gently hand-tighten with the hex key wrench while ensuring the leads are in the correct socket position.
- 7 If all laser leads are positioned properly, gently lower the contact arms on the sockets, and rotate the lock-latches over the arms until they snap in place.

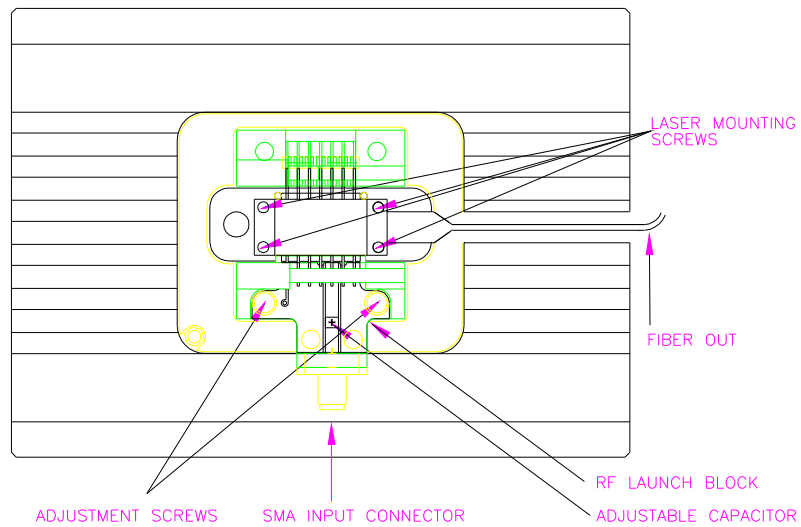

Figure 2.5 Top View of the LDM-4984RF Mount

- 8 Connect the SMA RF connector from the modulator source to the connector on the RF launch block. Observe safe laser handling practices by ensuring the RF signal source is not operating when the cable is connected.
- 9 Replace the grounded laser cover, ensuring it is pushed down completely over the grounding pin. The cover improves thermal stability and helps provide shielding from radiated noise and transients in the laboratory.

LDM-4983 and LDM-4983T Single-Side Butterfly Mounting

The LDM-4983 mount allows single-side Butterfly-package clamping and electrical connection through the use of a single flat ZIF socket. Once installed in the socket and clamped, the entire laser package bottom surface is clamped to a temperature controlled heat sink.

To mount a single-side butterfly-packaged laser diode, follow steps 1-8.

- 1 Open the sockets by releasing the lock-latch and lifting the contact arm.
- 2 Position both laser hold-down clamps away from the center of the heat sink. To move the clamps, simply lift up against spring pressure and rotate.

Alternatively, the laser package can be fastened to the heat sink to ensure greater heat transfer from the laser to the mount. To use this feature, remove the spring-loaded clamps with the provided hex key wrench. Do not install the hold down screws at this time; they will be installed once the laser is placed in the mount.

- 3 Holding the laser package by the corners, carefully lower the laser onto the heat sink, while aligning the laser leads with the socket contacts.
- 4 It is possible to misalign the leads when installing the laser. Verify that all leads are properly positioned in the socket before continuing. Failure to properly align the leads in the sockets may result in laser device damage.
- 5 Fix the laser package to the heat sink by rotating both clamps onto the package flange.

If the four hold-down screws are used in lieu of clamps, install the provided screws at the corners of the laser package and gently hand-tighten with the hex key wrench.

- 6 If all laser leads are positioned properly, gently lower the contact arm on the socket, and rotate the lock-latch over the arm until it snaps in place.
- 7 If the laser package has an RF connector on the side opposite the pins, connect the RF input cable while pressing the laser down with the other hand to prevent shifting the laser package and bending the leads. Observe safe laser handling practices by ensuring the RF signal source is not operating when the cable is connected.
- 8 After installing your laser, replace the grounded laser cover. The cover improves thermal stability and helps provide shielding from radiated noise and transients in your laboratory. Make sure that the cover is pushed completely down over the grounding pin.

LDM-4986, Connectorized Laser Mounting

The LDM-4986 allows simple case clamping and electrical connection through the use of a 4-pin socket. Once installed in the socket and clamped, the laser package mounting surface is coupled to a temperature controlled heat sink.

To mount a connectorized laser diode, follow steps 1-3 below.

- 1 Insert the laser diode into the 4-pin socket at the hotplate. Caution must be exercised to insert the laser correctly (laser pin-1 to socket pin-1, etc).
- 2 Position both laser hold-down clamps away from the center of the heat sink. To reposition the clamps, simply lift up against the spring pressure and rotate.

The mounting flange of connectorized lasers may be in the horizontal or vertical plane. The mount comes with the clamps mounted on the heat sink for a horizontal-mounted laser flange. If the laser has a vertical-mounted flange, simply unscrew the clamps with the provided hex wrench and fasten them to the heat sink vertical wall so the clamp posts are horizontal. There are two sets of mounting holes on the vertical wall; choose the appropriate holes for your particular laser.

- 3 Holding the laser package by the corners, carefully lower the laser onto the heat sink. Rotate each laser clamp onto the package flange and release.

Bias-T Option

The LDM-4982 and LDM-4984 mounts are available with an optional Bias-T to facilitate high-speed modulation. The Bias-T option accepts a 50 Ω impedance modulation input through a standard RF SMA connector on the end of the mount. When ordered with a Bias-T option, the pinout for laser cathode, laser anode, and ground are prewired by the specific type of Bias-T ordered (Options 481, 482A, 482B, - see specifications in Chapter 1). All other laser and TE functions must be configured per instructions given earlier in this chapter.

Case Temperature Control Option

An external case temperature control option with a built-in thermoelectric module and calibrated 10k Ω thermistor is also available with the LDM-4980 mounts. The external case temperature control option allows for control of laser package temperature, resulting in simultaneous and independent temperature control of both laser die temperature and package temperature.

When purchased with this option, the LDM-4980 mount wiring is factory configured.

A heat sink extension base (not shown) is also included with the option and must be used for optimal thermal performance. To gain access to the configuration header with this option, remove the base by unscrewing the four ¼-20 cap screws.

Note: The LDM-4982M and LDM-4986 come standard with the case temperature control option.

Current Sources and Current Measurements

If it is necessary to measure the current to your laser during operation, follow these steps.

- 1 Place a known resistance ($1\ \Omega$ works well) in series with the laser diode drive circuit.
- 2 Measure the voltage across the resistor.
- 3 Calculate the current by using Ohm's law: $I = V / R$.

CAUTION

NEVER connect an ammeter in series with the laser circuit.

If the ammeter executes an "autorange" while it is connected to the laser current supply circuit, the momentary open circuit during the range change will generate electrical transients. These transients may damage or destroy the laser.

NEVER turn the voltmeter on or off or change the voltage measurement range while current is flowing to the laser.

Performing any of these actions will cause a momentary open circuit through the voltmeter, generating electrical transients that will be transmitted to the laser. These transients may damage or destroy the laser.

ILX Lightwave current sources measure and display the actual current flowing through the laser. This information allows the user to read the output current during laser operation. Therefore, it is not necessary to measure the laser current as described above when using an ILX Lightwave source.

Disassembly

The LDM-4980 configuration headers can be easily accessed by removing the bottom cover. This is accomplished by removing the four rubber feet on the mount bottom by hand or with a #2 Phillips screwdriver. No further disassembly should be performed.

MAINTENANCE

No maintenance procedures are required for the LDM-4980 other than an occasional cleaning, as needed, to remove any accumulated dust or dirt from the external surfaces. For the LDM-4982 and LDM-4982M, it is recommended that a dummy 14-pin plug be installed in the socket if it is not being used for long periods of time. This will prevent accumulation of dust in the socket contacts. In lieu of this, the socket lever should be left in the horizontal position to close the contacts. For the butterfly-type mounts, leaving the contact arms in the down position will maintain contact reliability. It is recommended that the Bias-T SMA connector (if so equipped) be covered with an anti-static cap when not in use. Finally, always store the mount with the grounded laser cover installed.

SAFETY



Laser diodes used with the LDM-4980 Series Laser Diode Mount may emit infrared radiation, which is invisible to the human eye. Extreme care must be taken to prevent the beam from being viewed either directly or through external optics or mirrors. Remove rings, jewelry, and other reflective materials when working with lasers.

 **CAUTION**

Viewing of emissions from the fiber may cause eye damage. Use of protective goggles is recommended when operating these lasers.

 **CAUTION**

Use of controls or adjustments or performance of procedures other than those specified herein may result in hazardous radiation exposure.

This product conforms to all applicable DHHS regulations 21 CFR Subchapter J, at the date of manufacture.

