

tork

valve & automation



SOLENOID VALVE USER'S MANUAL

PLEASE READ THE INSTRUCTIONS BEFORE USE!



Lloyd



ROHS

TS EN264

UKSEPRO



CONTENTS

1. PRODUCT OVERVIEW.....	3
a. Intended Use of the Product.....	3
b. Product Coding System.....	4
c. Lists of Exploded Pictures and Parts.....	6
d. Label Information.....	8
e. Valves with Ex-Proof Solenoid Coils.....	9
2. PRODUCT OPERATION.....	10
a. Operation conditions.....	12
b. Electrical Limits of the Coils.....	13
3. PRODUCT INSTALLATION.....	14
Warnings.....	16
4. PRODUCT LIFE.....	19
5. PRODUCT CARE AND MAINTENANCE.....	19
6. PRODUCT SPARE PARTS.....	19
7. PRODUCT SHIPMENT.....	20
8. WARRANTY PERIOD FOR THE PRODUCT.....	20
9. PRODUCING COMPANY.....	20
10. WARRANTY CONDITIONS.....	21
11. WARRANTY CERTIFICATE.....	23

1. PRODUCT OVERVIEW

The solenoid valves are the electromechanical parts used in controlling the fluids. That is, they transform the electrical power into mechanical energy. This transformation is obtained via a magnetic circuit, which consists of solenoid coil. The term solenoid coil is also used for the valve.

a. Intended Use of the Product

The solenoid valves are the control elements that are used for the fluids. The functions of the solenoid may be summarized as to provide the flow, cut the flow, proportion correctly, to mix two mixtures. In the forms of 2/2-way and 3/2-way, the solenoid valves may be used in various applications. They are the valves used in the fluid control the most. They are used in many fluids such as air, water, steam, acid, gas, natural gas, fuel-oil, gasoline, LPG, diesel oil and etc.

The reasons to use the solenoid valves:

- They have a compact structure;
- Cost-saving
- Rapidly start the operations; low-energy consumption;
- Compatible with the material;
- Long life-cycle;
- High safety.

b. Product Coding System

S

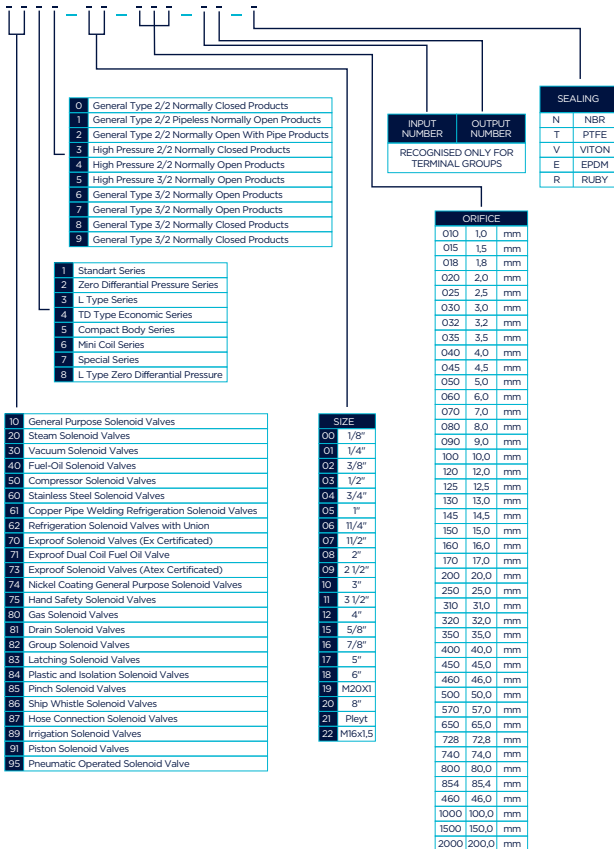

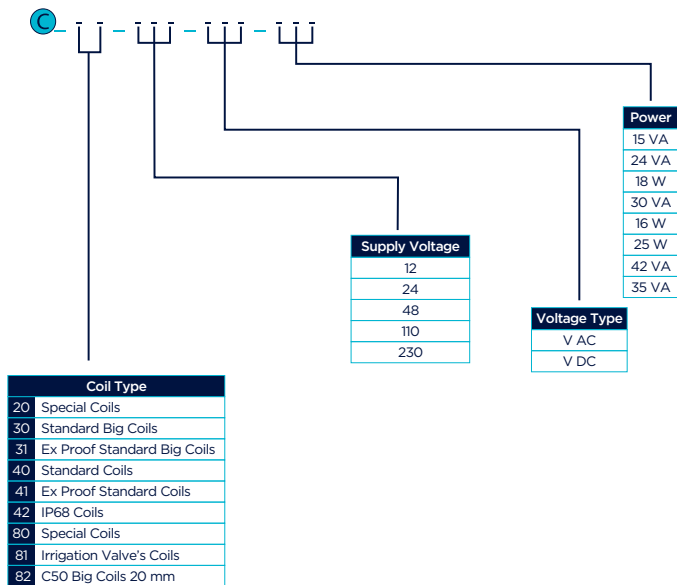

The code starting with **S** is the solenoid valve's code and the code starting with **C** is the coil's code used on the valve.

c. Lists of Exploded Pictures and Parts

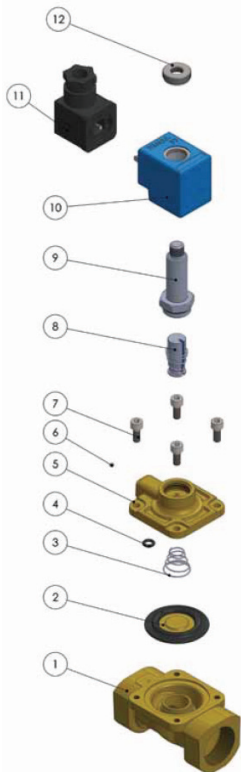

12	Knurled Nut	1	Piece
11	Socket	1	Piece
10	Coil	1	Piece
9	Tube	1	Piece
8	Core	1	Piece
7	Bolt	1	Piece
6	Ball	1	Piece
5	Cover	1	Piece
4	O - RING	1	Piece
7	Spring	1	Piece
6	Diaphragm	1	Piece
5	Body	1	Piece
No	Part Name	Quantity	Unit

Figure 1. Pilot-Control Solenoid Valve

Table 1. List of parts

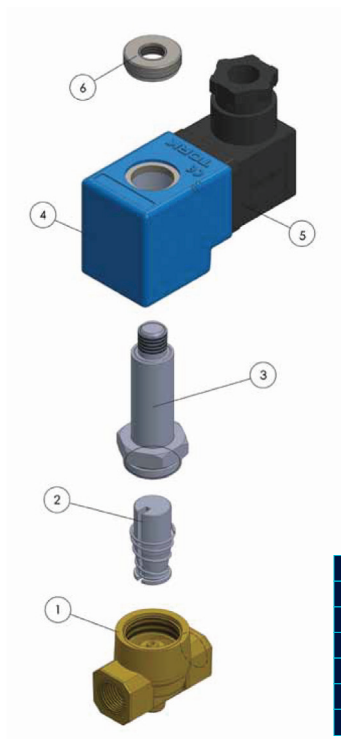

6	Knurled Nut	1	Piece
5	Socket	1	Piece
4	Coil	1	Piece
3	Tube	1	Piece
2	Core	1	Piece
1	Body	1	Piece
No	Part Name	Quantity	Unit

Figure 2. Direct Operated Solenoid Valves

Table 2. List of parts

d. Label Information

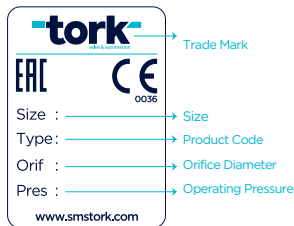

Figure 3. Labelling Details

The general specifications of the valve are also written on the label. Please find it the pictures below. For further details, please refer to the technical support team and sales team.

After purchasing the solenoid valve, please check the data on the label. It should be checked if it has the desired specifications or not. These data influence the operation of the valve therefore your system operation.

As shown in the figure 3, the connection scale is 1", orifice diameter is 17 mm, operating pressure is 0,5-40 bar. The protection class is IP65.

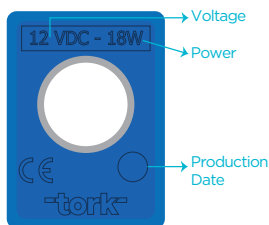

Figure 4. Coil Details

The data written on the coil, that is, the operating voltage, frequency, and power should be checked. The electrical limits of the coil should be compatible with your system. The coil with excessive power will cause power loss while the coil with less power will cause the valve not to operate. The date of manufacture should also be checked.

Please check the connection scale and flow direction. This is important both for conducting the proper assembly and proper operation of the system.

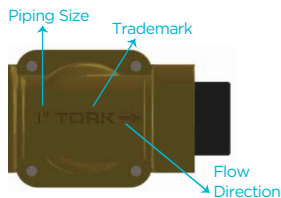

Figure 5. Details on the body -1
Please check the production date of the body as well.

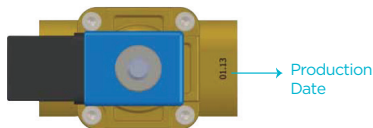

Figure 6. Details on the body -2

e. Valves with Ex-Proof Solenoid Coils

In explosive environments or the environments with explosion risk, the TORK solenoid coils with ATEX certification are used. The solenoid valves with ex proof coils can be used in, for example, LPG, natural gas, fuel-oil, and diesel oil. The operating voltage of the solenoid coils are as follows:

AC

230V

110V

24V

12V

DC

110V

24V

12V

All conductive materials in the ex-proof solenoid coils are encapsulated with non-conductors as a requirement of the standard. That's why; the coils are presented as assembled with IP65 socket and 3m power cable with ex proof specialities.

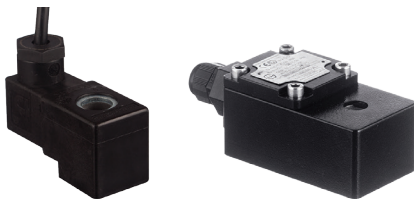

Figure 7: TORK M Class and D Class Stex Solenoid Valve Coil

Ex Codes Sample



II

2G

Explosive gas environment

Explosive environments except mines

Ex-Proof Sign



mb

IIB

T4

Temperature Class (surface temperature) 135 °C for T4

Gas Group

Protection type - Encapsulated Protection

Ex-Proof Sign

Ground Connection of Ex Proof Coils

For ex proof coils ground connection must be provided.

For AC coils you can use ground cable of the power cable.

This external ground cable must be connected to the grounding point shown on the Figure 8.



Figure 8. Ground connection of ex proof solenoid coils

2. PRODUCT OPERATION

When a certain amount of voltage (230V, 110V, 24V, and 12V DC or AC voltages) is applied to the solenoid coil, it transforms into an electromagnet and produces a magnetic power. This power allows the core in the valve to move. The valve is opened or closed according to this movement.

It is called as normally closed when the fluid does not flow in the case of no energy is available; while it is called as normally open when the fluid flows in the case of no energy is available.

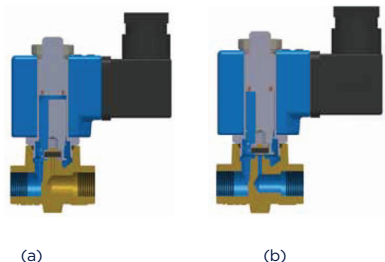

Figure 9: Normally-closed valve operation (a) while no power is available (b) while power is available with the coil

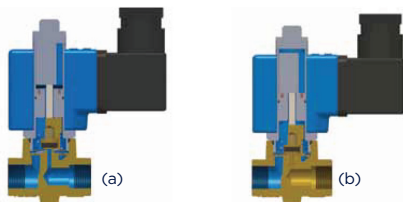
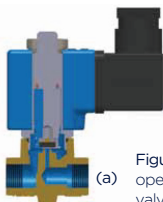

Figure 10: Normally - open valve operation (a) while no power is available (b) while power is available with the coil.

As shown in the Figure 11, when the power is given to the coil, the hose through which the fluid flows (orifice) directly gets closed or opened. Therefore, it is called 'direct-pull'.

The opening and closing operations of the pilot-control solenoid valves are conducted through a control segment and by using the line pressure. As shown in the Figure 12, the fluid in the line fills in the upper section of the diaphragm and flows down by means of line pressure and spring driving force to close the main hose. When the power given to the solenoid coil, the core is pulled up and the control hose is opened and the fluid in on the diaphragm is transferred to the line output through discharge port.



(a) Figure 11: Direct operated solenoid valve operation

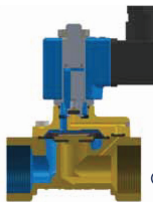

(b) Figure 12: Pilot-control solenoid valve operation

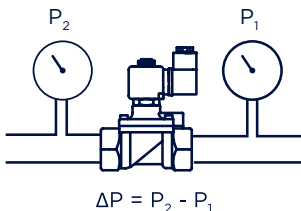

Operation Choices:

1. Direct-pull solenoid valves; $\Delta P \geq 0$ (general purpose series), $\Delta P \geq -1$ bar (vacuum series)
2. Pilot operated solenoid valves; $\Delta P \geq 0,5$ bar (general purpose series), $\Delta P \geq 0,3$ bar (mini series), $\Delta P \geq 0$ (zero line) are available.

a. Operation conditions

Pressure limits

The solenoid valves operate in different pressure limits from 1 bar to 100 bars. They are produced in the pressure standards between 0 bar 16 bars. For the pressure limits over 16 bars, the special valves are produced upon demand.

Temperature limits

The environment temperature for the solenoid valves' operation ranges between -10°C to +80°C. The temperature of the fluid that will pass through the solenoid valves is determined in accordance with the sealing element. The temperature limits are shown in Table 3.

Sealing Element	Fluid Temperature	
	Min. Temperature °C	Max Temperature °C
NBR	-10	80
VITON	-10	160
EPDM	-10	130
PTFE	-10	180
RUBY	-10	160

Table 3. The temperatures of the fluid passing through the solenoid valve

b. Electrical Limits of the Coils

The electrical limits of the coils are as shown in Table 4.



Coils used in valves are produced standard as IP65. On request IP68 coils or explosion proof coils are possible.

Coil	Voltage	Current	Power
C40, C41, C42, C43	12 VDC	1,5 A	18 W
	24 VDC	0,86 A	18 W
	110 VDC	0,175 A	18 W
	12 VAC	1,5 A	15 VA
	24 VAC	0,72 A	15 VA
	110 VAC	0,16 A	15 VA
	220 VAC	0,078 A	15 VA
	220 VAC	0,134 A	24 VA
C30, C31	12 VDC	1,28 A	16 W
	24 VDC	0,7 A	16 W
	12 VAC	2,35 A	30 VA
	24 VAC	1,3 A	30 VA
	110 VAC	0,275 A	30 VA
	220 VAC	0,135 A	30 VA
C20	12 VDC	0,417 A	5 W
	24 VDC	0,23 A	5 W
	24 VAC	0,3 A	7,2 VA
	110 VAC	0,064 A	7,2 VA
	220 VAC	0,032 A	7,2 VA
C50	12 VDC	2 A	25 W
	24 VDC	1A	25 W
	12 VAC	3 A	35 VA
	24 VAC	1,5 A	35 VA
	110 VAC	0,3 A	35 VA
	220 VAC	0,15 A	35 VA

Table 4. Electrical limits of the used coils.

3. PRODUCT INSTALLATION

! Before assembly, please make sure that there are no damages with the product and all required parts are available. The product should not be accepted in the case that it is damaged or if there are missing parts. Before using our products, please check the labels and other information on the product and package. Before assembly, please make sure that the line pressure does not exceed the maximum pressure specified on the product label. Before assembly, please check the compatibility of the product to be assembled with the system to be used. The operating limits specified in the technical specifications section should not be exceeded. Before assembly, please make sure that there is no flow in the line where the coil will be connected, and that such possibility has been prevented during the assembly. During the valve mount the proper wrench must be used.

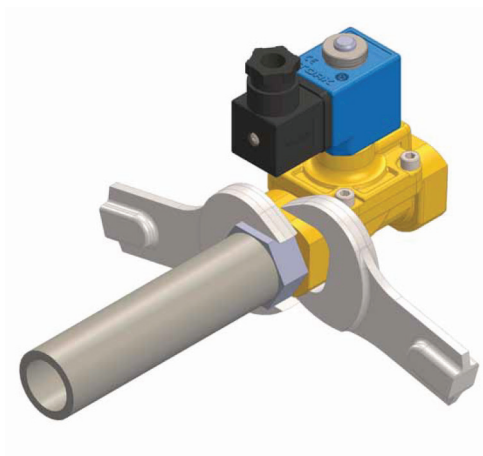

Figure 13. Solenoid valve assembly

After connecting the solenoid valve to the pipe system as shown in the Figure 14 and Figure 15, the coil is placed onto the valve manually as shown in the figures. After coil is fitted, it is manually screwed with knurled nut. The cable-connected socket is fitted to the coil and then fixed with fixing screw. In pipe type solenoid valve, the pipe is placed as shown in the Figure 15 and then screwed with the relevant wrench.

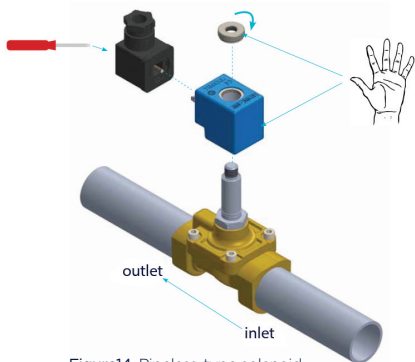

Figure14. Pipeless-type solenoid valve assembly

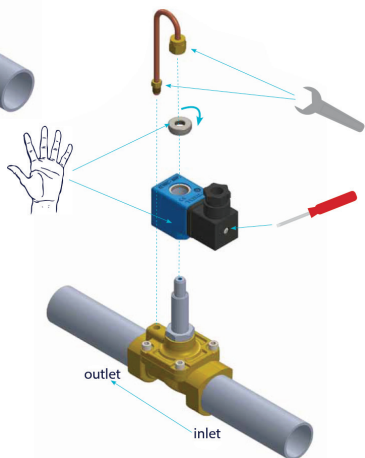

Figure 15. Pipe-type solenoid valve assembly

Warnings

- ❗ The coil gets hot in long-term operations. The hot coil may cause burnt if touched.
- ❗ The power should be connected to the coil via a socket, which should be closed. The power cable must be installed by an AUTHORIZED person. The open connections may cause electric shock and short-circuits.
- ❗ For protection from short circuit faults, a FUSE must be installed to the line of coil.
- ❗ The coil should be operated along with its own cover nut. The lack of cover nut may also cause damages to the coil or not to run.
- ❗ Every coil should operate under the voltage limits written on it. The higher or lower voltages may cause damages to the coils or not to run.
- ❗ Filters should be used for required fluids. The residuals and rusts accumulated in the valve may cause inconveniency for the coil to pull the core. This inconveniency may cause burn of the core.
- ❗ The pressure on the solenoid valve should be set to zero before removing it from the system.
- ❗ In critical applications like electronic cards coil must be controlled through a RELAY.

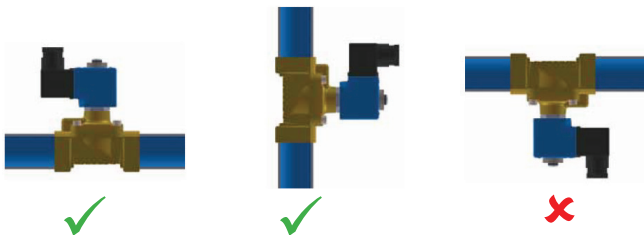

Figure 16. Solenoid valve connection form (a) Right, (b) Right, (c) Wrong

! In solenoid valve assembly, please be careful that the coil should not be at the lower part when conducting assembly. Otherwise, the core in the valve shall be affected by the residuals and rusts accumulated in time and prevent the coil to move the core. The solenoid valve may be assembled as shown in Figure 16 a or Figure 15 b.

! A filter should be used, if there are particles in the fluid to be used.

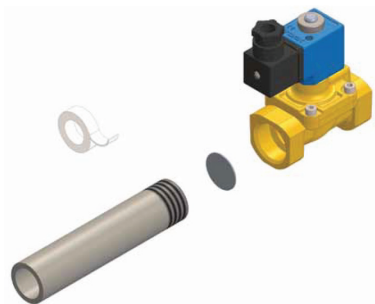

Figure 17. Using of filter and PTFE band

! Mounting by hand is not proper neither user health nor mounting health.

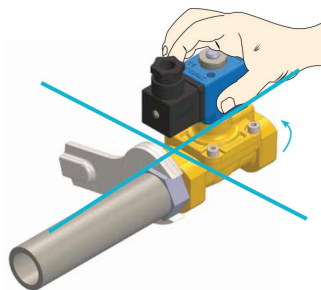

Figure 18. Wrong mounting of valve.

! When connecting the cable ends to connector, for AC voltages, the phaseneutral ends, and for the DC voltages, the positive (+) and negative (-) terminals should be connected to the number 1 and 2 connections. The earth terminal should be connected with the grounding conductor in the cable, if any. The grounding conductor is the yellow-green wire.

! Any bending or twisting should not be found with the cable connected to the connector in order to avoid any deficits resulting from any loose contact or short-circuit due to any crush. The cable should be uprights as shown in the Figure 17 a. In addition, the twists in the connector input may allow humidity to penetrate into the connector. In order to prevent humidity or water to leak into the socket, the diameter of the cable should be in a size that provides sealing.

! The coil should not run without tube. It means that it should run only when it is connected to the valve along with the tube and core. Otherwise, the conducting wire in the coil will burn and become dysfunctional within a short time. Figure 21 must be considered about this issue.

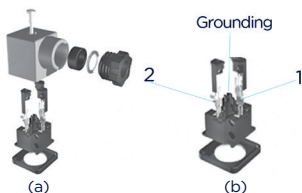

Figure 19. (a) Connector inner parts, (b) Connector connection points



Figure 20. The position of the connecting

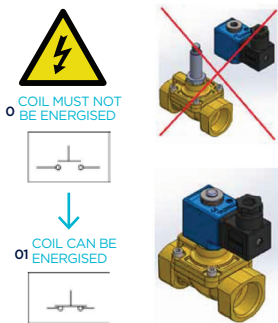



Figure 21. Warning about coil mounting.

4. PRODUCT LIFE

The opening and closing time for the product is under 1 s. The coil running with AC voltage is suggested if the solenoid coil will constantly operate, that is it will constantly stay under voltage. In turn, the coil running with DC voltage is suggested if the coil will run from time to time, a case that the open-close functions will function in certain cases. In this case, the risk of break of the valves is prevented before their expected lives.

5. PRODUCT CARE AND MAINTENANCE

According to the exploded pictures in pages 6 and 7, the solenoid valve is opened and the parts are examined and cleaned with the pressurized air. Particularly the core, diaphragm, diaphragm spring and orifice should properly be cleaned. The burrs and residuals on them should be removed. The damaged parts, if any, should be replaced with original TORK brand spare parts. The spare parts may be supplied from our company.

 Please be careful not to damage the sensitive inner parts during care and assembly. After any care or maintenance, the electrical connections should be checked, the required electrical measures should be taken and it should be tested if the valve is operating or not.

6. PRODUCT SPARE PARTS

The spare parts of the solenoid valves:

- Diaphragms
- Tube - core
- Coil
 - * Standard coil/Ex-proof
 - * Big Coil
 - * Mini coil/Ex-proof
- Socket
 - * Led sockets
 - * Normal sockets

You should choose the spare parts in the size compatible with the valve you use. Please contact our company to supply the spare parts and further information.

7. PRODUCT SHIPMENT

During shipment, the valve should not fall down or be exposed to solid impact. In addition, the tube and coil parts should also be protected from any damages. The weights that may damage the valve should not be placed on the packages of the solenoid valves. The products should be shipped in their original cardboard boxes.

8. WARRANTY PERIOD FOR THE PRODUCT

The warranty period for the TORK brand solenoid valves is two years. The maximum repair period is 20 days. The warranty does not include products if the valves are used out of scope of the terms of use specified when ordered from our company or in case of breaks resulted from the user's fault when the user try to conduct the care and repair of the product.

To benefit from the warranty, please apply to the manufacturer company with the warranty certificate approved by the company within the warranty period. In the case when you send the pneumatic piston valve via courier, please remember to add a description your complaint, the photocopy of your warranty certificate, your address and telephone number.

PRODUCING COMPANY

SMS SANAYİ MALZEMELERİ ÜRETİM VE SATIŞI A.Ş.

HEAD OFFICE

Y. Dudullu, Bostancı Yolu Kuru Sk. No:16 Ümraniye 34776 İstanbul/TURKEY
P: +90 216 364 34 05 F: +90 216 364 37 57 e-mail: tork@smstork.com

FACTORY

SMS Sanayi Malzemeleri Üretim ve Satışı A.Ş. İMES OSB 5. Cadde
No:6 Çerkesli - Dilovası / KOCAELİ / TURKEY
P: +90 262 290 20 20 F: +90 262 290 20 21 e-mail: tork@smstork.com

www.smstork.com

WARRANTY CONDITIONS

1. If there is a fault caused by the production, the manufacturer will repair or replace the defective product in its sole discretion.
2. The warranty period is two (2) years and starts from the date of delivery of the product to consumers.
3. All products, including all sub-parts, covered by our warranty.
4. The maximum repair time is one (1) month and starts from the products' arrival date to SMS factory.
5. Within the warranty period, both in material and workmanship, as well as in case of manufacturing defects, products will be repaired without any charge under any name (labor costs, or the cost of replaced parts).
6. During the warranty period, provided that the products will be exchanged free of charge if the fault is sourced by production.
7. Damages caused by the using of the product contrary to the points listed in the operating instructions are excluded from warranty coverage.
8. If there are complaints about the product please contact customer relations manager firstly.
9. For return or repair-maintenance of products send them to the factory to the customer relations department.
10. If products come to the factory, it doesn't mean acceptance of return and received by officers. Returns accepted, with the approval of the examination will be only after the relevant department managers.
11. Consult to General Directorate of Consumer and Competition Protection of the Ministry Industry and Commerce of Turkey about the issues may arise with warranty certificate.

EXCLUSIONS OF WARRANTY (USAGE DEFECTS)

1. Malfunctions occurring after the expiration of the statutory warranty,
2. The faults caused by improper use of the product by the user, (improper using to the instruction manual),
3. Any relevant malfunctions caused by other equipment in use,
4. Changes and damages not caused by the product manufacturer; for example, the case of the opening of the product by not authorized workshops,
5. All failures depend on the system (electricity, air, etc),
6. Failures depend on the intervention of unauthorized service,
7. Products with damaged or destroyed warranty label,
8. In case of damage to outer surface of the product,
9. The faults in the caused by falling, hit, etc,
10. Faults occurred on dusty, damp, extreme heat or cold environments,
11. Faults caused by natural disasters such as flood, fire, earthquake, lightning, etc,
12. Faults caused by electrostatic discharge (ESD) damage.



WARRANTY CERTIFICATE

Manufacturer : SMS Sanayi Malzemeleri Üretim ve Satışı A.Ş.

Address : Head Office: Y.Dudullu Mh. Bostancı Yolu Kuru Sk.
No:16 Ümraniye - İstanbul / TURKEY

Factory: İMES O.S.B 5. Cd. No: 6 Çerkeşli OSB Mh.
Dilovası - Kocaeli / TURKEY

Product :

Trade Mark : TORK

Model :

Serial Number :

Delivery Place & Date :

Warranty Period :

Max. Repair Time :

Seller / Distributor :

Address :

.....

.....

.....

Manufacturer Representative

Name / Surname :

Title :

Date :

Signature :

Seller / Distributor Representative

Name / Surname :

Title :

Date :

Signature :



SECTOR
LEADER WITH
30 YEARS
EXPERIENCE





bsi.



Certificate of Registration

QUALITY MANAGEMENT SYSTEM - ISO 9001:2008

This is to certify that: **SMS-Türk Endüstriyel Otomasyon Ürünleri Sanayi ve Ticaret Ltd. Sti.**
Boşaziçe Yolu Kurum Sokak No : 16
Yıldırım Dükümü
Umraniye/İstanbul
34716
Turkey

Holds Certificate No: **FM 647592**
and operates a Quality Management System which complies with the requirements of ISO 9001:2008 for the following scope:

Design, production and sales of industrial valves, automation, control and measurement equipment.

For and on behalf of BSI: Frank Lee, ENQA Compliance & Risk Director

Original Registration Date: 04/09/2013
Latest Revision Date: 31/05/2016

Effective Date: 31/05/2016
Expiry Date: 31/05/2018
Page: 1 of 2



„making excellence a habit“

This certificate only certifies conformity and remains the property of BSI and is issued by the conditions of product. An electronic certificate can be authentic only if issued by BSI. This notice can be verified at www.bsi.com/bsi/certificates or telephone +44 (0) 1223 900111. Information and Contact: BSI, Mansfield Park, 389, Marsh Road, Marlow, Bucks. HP81 9BT, UK. Tel: +44 (0) 1223 393000. BSI American UK Limited, registered in England under number 7805111 at 389 Church Hill Road, Boreham, UK. Tel: +44 (0) 1223 393000.

tork

valve & automation

KUL006EN/07.02.2017/00

MERKEZ OFİS Bostancı Yoju Cad, Kuru Sok, No16 Y, Dudu[[u, 34776 Ümraniye İstanbul - TÜRKİYE **T** +90 216 364 34 05 **F** +90 216 364 37 57

FABRİKA İMES O.S.B. 5. Cad, No6 Çerkeşli O.S.B. Mah, Dilovası Kocaeli - TÜRKİYE **T** +90 262 290 20 20 **F** +90 262 290 20 21

SMS-TORK Endüstriyel Otomasyon Ürünleri San, Tic, Ltd, Sti,

f/SMSTORK **@**/sms-tork www.smstork.com